

CONCRETE PIPE & BOX CULVERT



INSTALLATION

CONCRETE PIPE & BOX CULVERT

INSTALLATION



American **Concrete Pipe** Association

info@concretepipe.org

Table of Contents

I. CONCRETE PIPE INSTALLATION MANUAL

Introduction

PRE-CONSTRUCTION

Precautions.....	6
Ordering, Receiving And Handling.....	6
Unloading.....	7
Stockpiling.....	10

INSTALLATION.....

Line And Grade.....	12
Excavation Limits.....	17
Excavated Material.....	19
Dewatering.....	19
Standard Installations.....	20
Class A Bedding.....	27
Class B Bedding.....	27
Class C Bedding.....	28
Class D Bedding.....	29
Gasket Installations.....	38
“O” Ring Gaskets.....	43
Self Lubricating.....	44
Roll-on Gaskets.....	45
Mastic.....	46
Mortar.....	46
Geotextile Filter Fabrics.....	47
External Bands.....	47
Joint Procedures.....	47
Service Connections.....	50
Curved Alignment.....	50
Flowable Fill.....	53
Final Backfilling.....	54
Acceptance Tests.....	55
Soil Density.....	55
Line And Grade.....	57
Visual Inspection.....	57
Infiltration.....	58
Exfiltration.....	60
Air Testing.....	63

Vacuum Testing.....	66
Joint Testing-Air.....	66
Joint Testing-Water.....	67
Multiple Pipe Installations.....	68
Flat Trench.....	68
Bended Trench.....	69
II. BOX CULVERT INSTALLATION MANUAL.....	71
Introduction.....	71
PRE-INSTALLATION.....	72
Precautions.....	72
Ordering, Receiving & Handling.....	72
Scheduling / Unloading / Placing / Sequence.....	73
Storing.....	74
SITE PREPARATION.....	76
Excavation.....	76
Trenchwater.....	77
Bedding/Grade.....	77
INSTALLATION.....	80
Box Alignment.....	80
Box Placement.....	80
Jointing.....	80
Connecting the Boxes.....	82
Completion.....	83
Backfill.....	83
Minimum Cover For Construction Loads...	84
Visual Inspection.....	85
III. SPECIFICATIONS	86
IV. APPENDIX.....	94
Definitions.....	94
Feet Head of Water into Pressure, Pounds Per Square Inch.....	97
Feet Head of Water into Kilopascals (kN/m ²).....	97

I. CONCRETE PIPE INSTALLATION MANUAL

INTRODUCTION

This manual presents a guide for the proper installation of concrete pipe. For many years, the American Concrete Pipe Association has conducted comprehensive research and analysis of the factors which affect the field performance of concrete pipe. The knowledge and beneficial practices gained through research and experience are presented in this manual.

While focusing on the construction of the pipe-soil system, this manual also addresses those factors critical to the completion of the entire system, from delivery of the concrete pipe to the jobsite, to the acceptance of the installed pipeline.

This manual is intended as a guide and is not to supersede the project specifications.

PRE-CONSTRUCTION

PRECAUTIONS

Federal regulations covering safety for all types of construction, including sewer and culvert installations, are published in the Safety and Health Regulations for Construction under the Department of Labor, Occupational Safety and Health Administration (OSHA). These regulations are applicable to all prime contractors and subcontractors involved in any type of construction, including alterations and repair work.

The installer should also review installation practices with the engineer's design assumptions, particularly in relation to the use of trench boxes and compaction requirements of the backfill.

ORDERING, RECEIVING AND HANDLING

Although the ordering of materials is the contractor's responsibility, supplier and engineer familiarity with the contractor's proposed schedule will enable better coordination to avoid mistakes and possible delays in pipe deliveries. Pipe manufacturers stock a wide range of pipe sizes and strengths, but production facilities must frequently be adapted to meet specific project requirements, particularly when large quantities and/or special types of pipe are involved. Information required to initiate a pipe order should be in writing and include:

- name and location of project
- pipe size, laying length and strength
- total footage of each type and size of pipe
- type of joint
- size and quantity of manhole base sections, riser sections, cone sections and grade rings
- list of fittings and specials including radius pipe

- laying sequence
- required specifications
- material test requirements
- joint material and quantity
- invoicing instructions

The pipe should be checked for the following information, clearly marked on each pipe section:

- specification designation
- pipe class or strength designation
- span, rise, table number, top of box and design earth cover for ASTM C 1433(M) or C 1577(M), or AASHTO M259(M) or M273(M) box sections
- date of manufacture
- name or trademark of the manufacturer
- for reinforced pipe with elliptical or quadrant reinforcement orientation, the letters E or Q, respectively and “top”.

UNLOADING

Unloading of pipe should be coordinated with the construction schedule and installation sequence to avoid re-handling and unnecessary equipment movement. Access to the jobsite shall be provided by the contractor to ensure that the pipe manufacturer’s trucks can deliver pipe to the unloading area under their own power.

Each shipment of pipe is loaded, blocked and tied down at the plant to avoid damage during transit. However, it is up to the receiver to make certain damage has not occurred in delivery from the plant to the construction site. An overall inspection of each pipe shipment should be made on arrival, before the pipe is unloaded. Total quantities of each item should be checked against the delivery slip and any damaged or missing items recorded on the delivery document.

If a pipe is damaged during delivery or unloading, the pipe should be set aside. Damaged ends, chips or cracks, which do not pass through the wall, can usually be repaired.

Many carriers are equipped with automatic unloaders, which further expedite the unloading of circular pipe. These automatic unloaders consist of a forklift type of apparatus mounted at the rear of a flat bed truck. The forks rotate vertically rather than move up and down, such that, when the forks are in a vertical position they extend above the truck bed. This provides a backstop and cushion for the pipe sections as they are rolled to the rear of the truck for unloading. A cradle formed by the forks and unloader frame securely retains the pipe section being unloaded as the forks are rotated downward and lowered to the ground.

AUTOMATIC UNLOADER

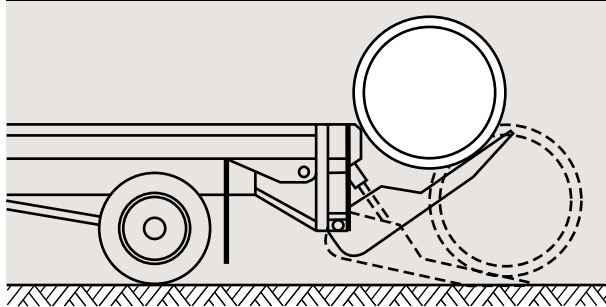

Unloading of the pipe should be controlled so as not to collide with the other pipe sections or fittings, and care should be taken to avoid chipping or spalling, especially to the spigots and bells. Caution should be exercised to be sure personnel are out of the path of the pipe as it is lowered.

If the pipe has to be moved after unloading, the sections should be rolled or lifted and should never be dragged. Pipe sections should not be rolled over rough or rocky ground.

The use of mechanical equipment is necessary for unloading arch, elliptical and box sections and larger size circular pipe, and can usually simplify and speed up the unloading of smaller pipe. When using mechanical equipment for unloading, the lifting device, which connects to the pipe, should enable proper and safe handling without damage to the pipe. Lifting devices such as slings, chain, steel wire, cable and rope should be placed around the pipe and arranged so that the pipe is lifted in a horizontal position. If the lifting device could chip or damage the pipe, padding should be provided between the pipe and lifting device. These types of lifting devices should not be passed through the pipe. Other devices, which are designed to pass into or through the pipe, should not touch the spigot or bell jointing surfaces, and should extend far enough beyond the end of the pipe for adequate clearance of lifting lines.

LIFT HOLD DEVICES

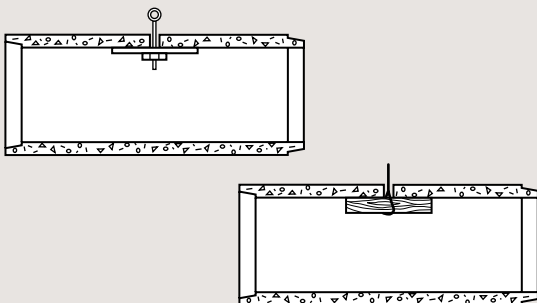

When pipe is provided with lifting holes, the lifting device should pass through the wall and distribute the weight along the inside barrel of pipe.

The most common lifting device for use with lifting holes consists of a steel threaded eye bar with a wing type nut and bearing plate. If a specially designed lifting device is not readily available, a single looped sling can be passed through the lift hole into the bore of the pipe and then around a piece of timber of adequate length and cross-section to assure structural stability. For manhole sections, cone sections, bases, fittings and other precast appurtenances, the lifting holes or lifting eyes provided should be used.

Regardless of the method used to unload pipe, precautions should be taken to avoid damage to the pipe and assure the pipe is unloaded in a safe manner.

STOCKPILING

Any stockpiling of pipe should be as near as possible to where the pipe will be installed. Small diameter pipe should be layered in the same manner as they were loaded on the truck. The bottom layer should be placed on a flat base, adequately blocked to prevent shifting as more layers are added. Each layer of bell and spigot pipe should be arranged so that all the bells are at the same end. The bells in the next layer should be at the opposite end, and projecting beyond the spigots of the pipe sections in the lower layer. Where only one layer is being stockpiled, the bell and spigot ends should alternate between the adjacent pipe sections. All pipes should be supported by the pipe barrel so that the joint ends are free of load concentrations. Pipe sections generally should not be stockpiled at

the job site in a greater number of layers than would result in a height of 6 ft. (2 m).

All flexible gasket materials not cemented to the pipe, including joint lubrication compounds, should be stored in a cool dry place to be distributed as needed. Rubber gaskets and preformed or bulk mastics should be kept clean, away from oil, grease, and excessive heat and out of the direct rays of the sun.

INSTALLATION

LINE AND GRADE

The elevation of the pipe invert for storm drain pipe shall not deviate from the design elevation by more than plus or minus two percent (+/- 2%) of the pipe size being installed, or one inch (1"), whichever is greater. The rate of deviation to/from grade shall be limited to one-sixteenth of an inch (1/16") per foot (1') of pipe.

For sewer and culvert construction, line and grade are usually established by one or a combination of the following methods:

- reference line established by a helium-neon laser
- control points consisting of stakes, spikes, plugs or shiners set at the ground surface and offset a certain distance from the proposed sewer centerline
- control points established at the trench bottom after the trench is excavated.
- trench bottom and pipe invert elevations while excavation and pipe installation progresses

Specially designed helium-neon lasers are available for sewer and culvert construction. Basically the instrument converts input power into a beam of light, which is projected as a narrow beam rather than shining in all directions as does a light bulb. The light beam is a continuous, uninterrupted string line, which does not sag and can be used for distances up to 1,000 ft. (90 to 150 m). The laser projects a beam of light the diameter of which depends on the distance being projected and on the optics of the particular instrument. Usually the beam is about the size of a pencil. Since the laser beam is a light beam, it is seen by either looking back at

the instrument or intercepting the beam with target, which reflects the light.

As with any surveying instrument, the initial setting is most important. But once a laser is set as to direction and grade, it provides a constant reference line from which measurements can be taken at any point along the beam. A workman with any

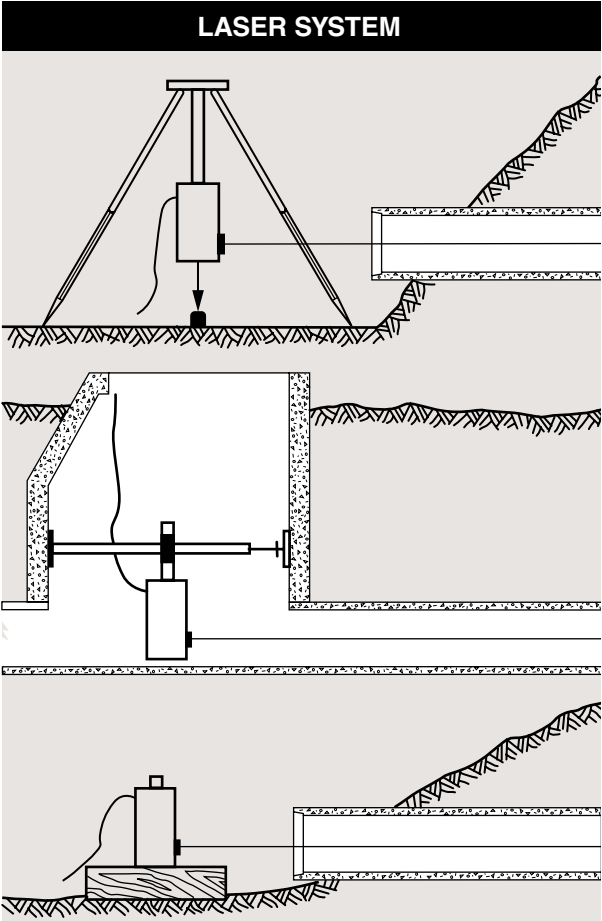

ordinary rule or stadia rod can measure offsets for construction quickly and accurately, generally within 1/16 in. (1.58 mm) or less. The laser instrument can be mounted in a manhole, set on a tripod or placed on a solid surface to project the light beam either inside or outside the pipe.

The low-powered helium-neon laser used in construction is not considered to be a dangerous instrument. Although anyone deliberately staring into a 1 to 3 milliwatt laser for a sufficient time could receive damage to the eye (that is comparable to staring directly into the sun, or a welder's arc).

When pipe is installed by the jacking or tunneling method of construction, an accurate control point must be established at the bottom of the jacking pit or work shaft. Close control of horizontal and vertical alignment can be obtained by a transit or laser. If excavation and pipe installation extend several hundred feet (meters) from one shaft, or the horizontal alignment is curved, vertical line pipes can be driven from the surface through which plumb lines can be dropped. In many cases vertical holes are drilled from the surface for lubricating the outside of the pipe or grouting and these can be used to check line and grade.

Where control points are established at the surface and offset, batter boards, tape and level, or specially designed transfer instruments are used to transfer line and grade to the trench bottom. Regardless of the specific type of transfer apparatus used, the basic principles are:

- stakes, spikes, plugs or shiners as control points are driven flush with the ground surface at 25 to 50 ft. (7.5 to 15 m) intervals for straight alignment with shorter intervals for curved alignment

- offset the control points 10 ft. (3 m) or other convenient distance on the opposite side of the trench from which excavated material will be placed
- determine control point elevations by means of a level, transit or other leveling device and indicate on the guard stake driven next to the control point the depth from the control point to the trench bottom or pipe invert
- by means of longer grade stakes, driven immediately adjacent to the control points, a continuous string line is tied to the grade stakes at a specific distance above the trench bottom or pipe invert
- after the surface control points are set, a cut sheet is prepared listing reference points, stationing, offset distance and vertical distance from the control points to the trench bottom or pipe invert

For narrow trenches a horizontal batter board is spanned across the trench and adequately supported at each end. The batter board is set level at the same elevation as the string line and a nail driven in the upper edge at the centerline of the pipe. In many cases the batter board is used only as a spanning member with a short vertical board nailed to it at the pipe centerline. A string line is then pulled tight across a minimum of three batter boards and line transferred to the trench bottom by a plumb bob cord held against the string line. Grade is transferred to the trench bottom by means of a grade rod or other suitable vertical measuring device.

Where wide trenches are necessary, due to large pipe sizes or sloped trench walls, the batter board may not be able to span the width of exca-

vation. In such cases, the same transfer principle is used, except that the vertical grade rod is attached to one end of the batter board and the other end set level against the offset string line. The length of the horizontal batter board is the same as the offset distance and the length of the vertical grade rod is the same distance between the trench bottom or pipe invert and the string line. Specially designed instruments are available which incorporate a measuring tape, extendable arm and leveling device. These instruments are based on the same principle, but

EXAMPLE BATTER BOARD SET-UP

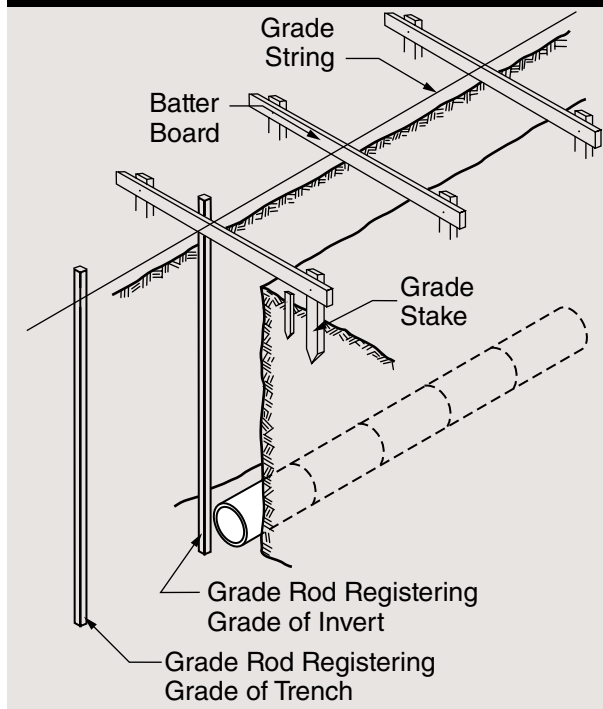

eliminate the need to construct batter boards and supports and are portable.

The transfer of surface control points to stakes along the trench bottom is sometimes necessary because of the deep trenches or unstable soils requiring the trench sides to be sloped back. Stakes should be set along the trench bottom at 50 ft. (15 m) intervals and a string line drawn between two or three control points. Where line and grade are established as excavation proceeds, a transit, level or laser setup is usually used.

In setting line and grade for culverts installed at about the same elevation as the original ground, culvert control points are usually established during the construction survey. Stakes are then set along the culvert length by means of a hand level or survey instrument. If the embankment is first built up and then a sub-trench excavated, the same procedures as for trench excavations can be used.

EXCAVATION LIMITS

The most important excavation limitations are trench width and depth. As excavation progresses, trench grades should be continuously checked against the elevations established in the sewer or culvert profile. Improper trench depths can result in high or low spots in the line, which may adversely affect the hydraulic capacity of the sewer or culvert and require correction or additional maintenance after the line is completed.

The backfill load transmitted to the pipe is directly dependent on the trench width. To determine the backfill load, the designer assumes a certain trench width and then selects a pipe strength capable of withstanding this load. If the constructed trench width exceeds the width assumed in design, the pipe could be overloaded and possibly structur-

ally distressed. Because the backfill loads and pipe strength requirements are a function of the trench width, maximum trench widths are usually established in the plans or standard drawings. Where maximum trench widths are not indicated in any of

TRENCH WIDTH FOR CONCRETE PIPE			
Pipe Diameter (inches)	Trench Width (feet)	Pipe Diameter (millimeters)	Trench Width (millimeters)
4	1.6	100	470
6	1.8	150	540
8	2.0	200	600
10	2.3	250	680
12	2.5	300	800
15	3.0	375	910
18	3.4	450	1020
21	3.8	525	1100
24	4.1	600	1200
27	4.5	675	1300
33	5.2	825	1600
36	5.6	900	1700
42	6.3	1050	1900
48	7.0	1200	2100
54	7.8	1350	2300
60	8.5	1500	2500
66	9.2	1650	2800
72	10.0	1800	3000
78	10.7	1950	3200
80	11.4	2100	3400
90	12.1	2250	3600
96	12.9	2400	3900
102	13.6	2550	4100
108	14.3	2700	4300
114	14.9	2850	4500
120	15.6	3000	4800
126	16.4	3150	5000
132	17.1	3300	5200
138	17.8	3450	5400
144	18.5	3600	5600

NOTE: Trench widths based on $1.25 B_c + 1 \text{ ft.}$ ($1.25 B_c + 300\text{mm}$) where B_c is the outside diameter of the pipe in inches (mm).

the construction contract documents, trench widths should be as narrow as possible, with side clearance adequate enough to insure proper compaction of backfill material at the sides of the pipe. The following trench widths can be used as a general guide for circular concrete pipe:

EXCAVATED MATERIAL

If excavated material is to be stored on top of the pipeline, special consideration should be given to surcharge loading during the design of the pipe.

Stockpiling excavated material adjacent to the trench causes a surcharge load, which may cave in the trench walls. The ability of the trench walls to stand vertically under this additional load depends on the cohesive characteristics of the particular type of material being excavated. This surcharge load should be considered when evaluating the need to provide trench support. It may be necessary where deep or wide trenches are being excavated to haul away a portion of the excavated soil or spread the stockpile with a bulldozer or other equipment. If the excavated material is to be used as backfill, the stockpiled material should be visually inspected for rocks, frozen lumps, highly plastic clay or other objectionable material. If the excavated soil differs significantly from the intended backfill material set forth in the plans, it may be necessary to haul the unsuitable soil away and bring in select backfill material.

DEWATERING

Control of surface and subsurface water is required so that dry conditions will be provided during excavation and pipe laying. Ground water conditions should be investigated before they are encountered during the course of excavation.

STANDARD INSTALLATIONS

Through consultations with contractors and engineers, four Standard Installations were developed and are presented in the following pages. The following ideas, formulated from past experience, were confirmed with parameter studies. These Standard Installations represent an improved understanding of the installation factors effecting pipe performance and reflect modern construction techniques. They are designed to improve pipe performance by emphasizing beneficial construction and installation requirements. By providing installations, which utilize a wide range of backfill materials, including native materials, the Standard Installations offer the owner, engineer, and contractor more versatility in selecting the installation to meet their unique combination of site conditions, backfill materials and desired construction and inspection materials. Some of the ideas included in the Standard Installations confirm the following concepts:

- The soil in the haunch area from the foundation to the pipe springline provides significant support to the pipe and reduces pipe stresses.
- Loosely placed, uncompacted bedding directly under the invert of the pipe significantly reduces stresses in the pipe.
- Installation materials and compaction levels below the springline have a significant effect on pipe structural requirements.
- Soil in those portions of the bedding and haunch areas directly under the pipe is difficult to compact.
- Compaction level of the soil directly above the haunch, from the pipe springline to the top of the pipe grade level, has negligible effect on pipe stresses. Compaction of the soil in

this area is not necessary unless required for pavement structures.

These Standard Installations identify four principal zones surrounding the lower half of the pipe, which are critical to the pipe-soil system. The four zones are the middle bedding, the outer bedding, the haunch and the lower side. The type of material (based on soil characteristics) and level of compaction, and the material utilized in construction of these important zones varies with the installation type 1, 2, 3 and 4.

For those projects still using the older bedding types, bedding types, A, B, C and D are presented.

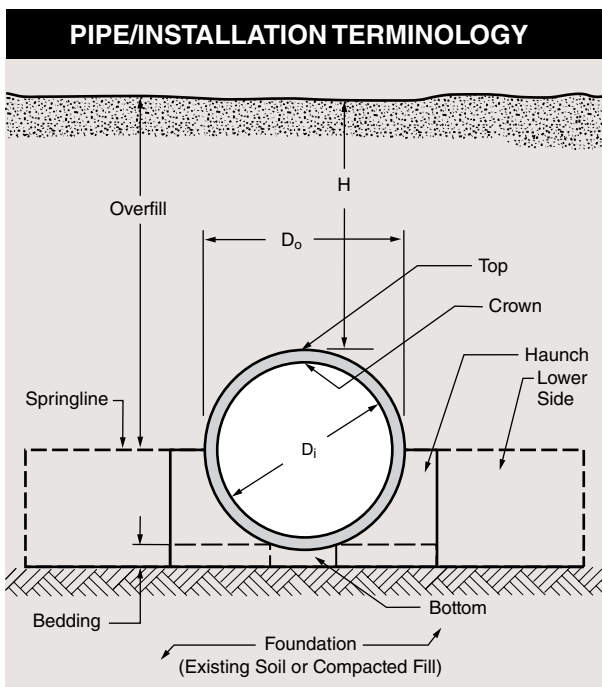

STANDARD TRENCH / EMBANKMENT INSTALLATION

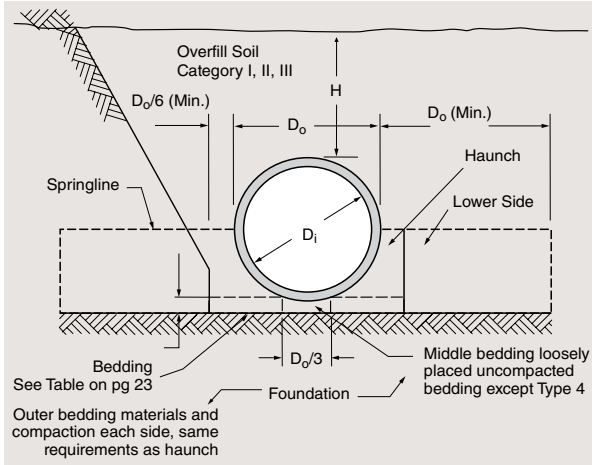

EQUIVALENT USCS AND AASHTO SOIL CLASSIFICATIONS FOR SIDD SOIL DESIGNATIONS

SIDD Soil	Representative Soil Types		Percent Compaction	
	USCS	AASHTO	Standard Proctor	Modified Proctor
Gravelly sand (Category I)	SW, SP GW, GP	A1, A3	100	95
			95	90
			90	85
			85	80
			80	75
61	59			
Sandy Silt (Category II)	GM, SM, ML Also GC, SC with less than 20% passing #200 sieve	A2, A4	100	95
			95	90
			90	85
			85	80
			80	75
49	46			
Silty Clay (Category III)	CL, MH GC, SC	A5, A6	100	90
			95	85
			90	80
			85	75
			80	70
45	40			

STANDARD INSTALLATIONS SOILS AND MINIMUM COMPACTION REQUIREMENTS			
Installation Type	Bedding Thickness	Haunch and Outer Bedding	Lower Side
Type 1	D ₀ /24 minimum, not less than 3in. If rock foundation, use D ₀ /12 minimum; not less than 6in.	95% Category I	90% Category I, 95% Category II or 100% Category III
Type 2	D ₀ /24 minimum, not less than 3in. If rock Foundation, use D ₀ /12 minimum; not less than 6in.	90% Category I or 95% Category II	85% Category I, 90% Category II or 95% Category III
Type 3	D ₀ /24 minimum, not less than 3in. If rock foundation, use D ₀ /12 minimum, not less than 6in.	85% Category I, 90% Category II, or 95% Category III	85% Category I, 90% Category II, or 95% Category III
Type 4	D ₀ /24 minimum, not less than 3in. If rock foundation, use D ₀ /12 minimum, not less than 6in.	No compaction required, except if Category III, use 85% Category III	No compaction required, except if Category III, use 85% Category III

Notes:

1. Compaction and soil symbols - i.e. "95% Category I"- refers to Category I soil material with minimum standard Proctor compaction of 95%. See Table on page 22 for equivalent modified Proctor values.
2. Soil in the outer bedding, haunch, and lower side zones, except under the middle 1/3 of the pipe, shall be compacted to at least the same compaction as the majority of soil in the overfill zone.
3. For Type 1 installation, crushed rock is not an appropriate material for bedding under the pipe. An uncompacted, non-crushed material must be used under the pipe. While crushed rock meeting the requirements of this specification may self compact vertically, it will not flow laterally to provide support for the haunches of the pipe. To achieve a 90-95% compaction with crushed rock, work material under the haunch and compact it to achieve the specified density. Otherwise, the specified installation is not achieved.
4. For trenches, top elevation shall be no lower than 0.1 H below finished grade or, for roadways, its top shall be no lower than an elevation of 1 foot below the bottom of the pavement base material.
5. For trenches, width shall be wider than shown if required for adequate space to attain the specified compaction in the haunch and bedding zones.
6. For trench walls that are within 10 degrees of vertical, the compaction or firmness of the soil in the trench walls and lower side zone need not be considered.
7. For trench walls with greater than 10 degree slopes that consist of embankment, the lower side shall be compacted to at least the same compaction as specified for the soil in the backfill zone.
8. Subtrenches
 - 3.1 A subtrench is defined as a trench with its top below finished grade by more than 0.1 H or, for roadways, its top is at an elevation lower than 1ft. below the bottom of the pavement base material.
 - 3.2 The minimum width of a subtrench shall be 1.33 D₀ or wider if required for adequate space to attain the specified compaction in the haunch and bedding zones.
 - 3.3 For subtrenches with walls of natural soil, any portion of the lower side zone in the subtrench wall shall be at least as firm as an equivalent soil placed to the compaction requirements specified for the lower side zone and as firm as the majority of soil in the overfill zone, or shall be removed and replaced with soil compacted to the specified level.

HORIZONTAL ELLIPTICAL PIPE STANDARD EMBANKMENT INSTALLATIONS

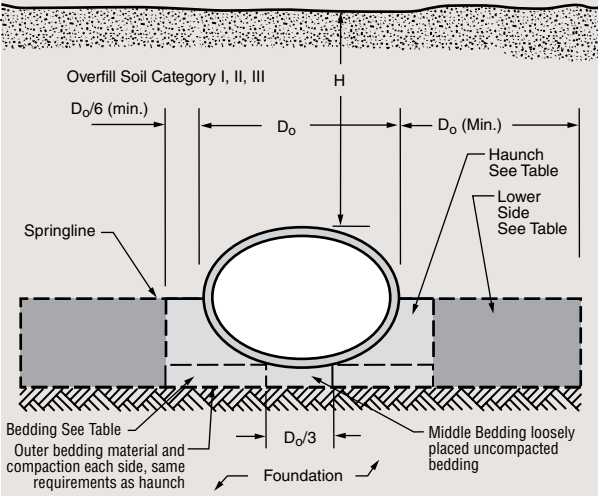

HORIZONTAL ELLIPTICAL PIPE STANDARD TRENCH INSTALLATIONS

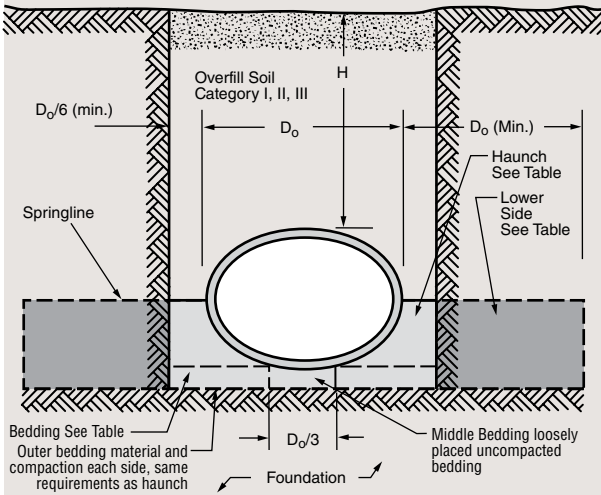

VERTICAL ELLIPTICAL PIPE STANDARD EMBANKMENT INSTALLATIONS

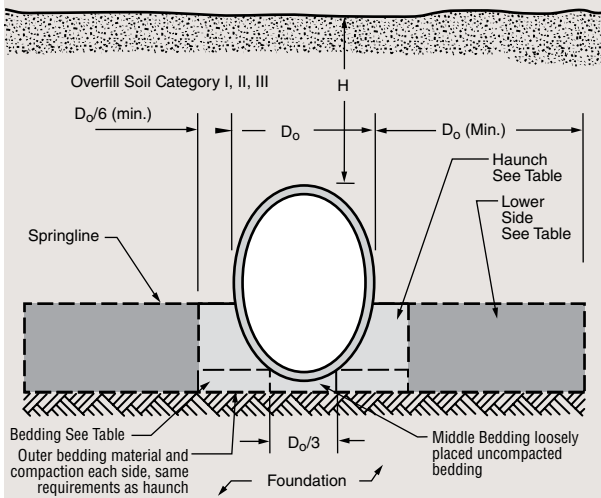

VERTICAL ELLIPTICAL PIPE STANDARD TRENCH INSTALLATIONS

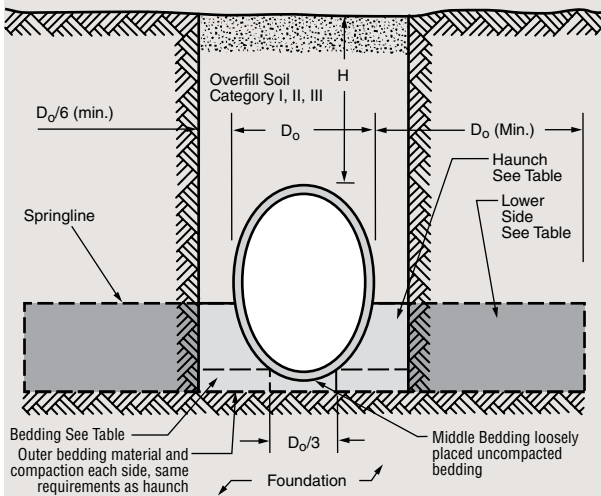

ARCH PIPE STANDARD EMBANKMENT INSTALLATIONS

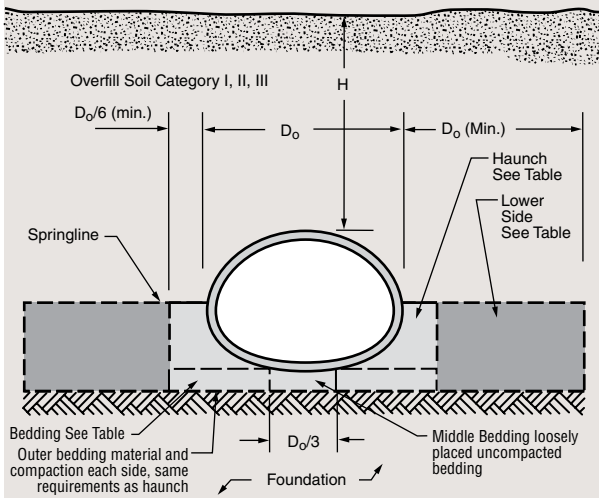

ARCH PIPE STANDARD TRENCH INSTALLATIONS

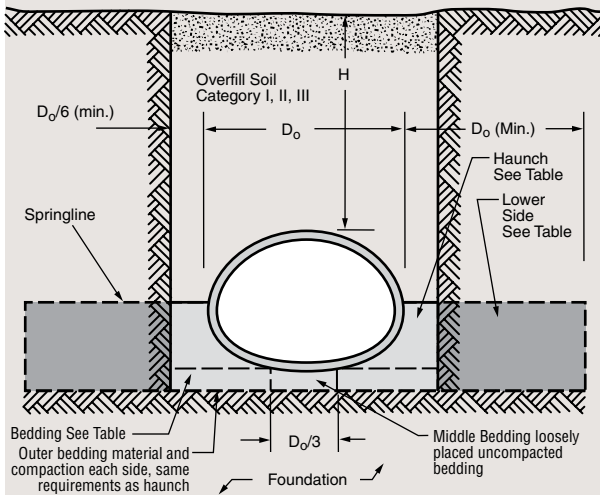

CLASS A BEDDING

CONCRETE CRADLE

CONCRETE CRADLE – Used only with circular pipe, the pipe is bedded in non-reinforced or reinforced concrete having a thickness, *d*, as listed, and extending up the sides for a height equal to the outside diameter. The cradle should have a minimum width at least equal to the outside diameter of the pipe plus 8 in. (200 mm). The backfill above the cradle is densely compacted and extends 12 in. (300 mm) above the crown of the pipe. In rock, especially where blasting is likely in the adjacent vicinity, the concrete cradle should be cushioned from the shock of the blasting which can be transmitted through the rock.

CLASS B BEDDING

SHAPED OR UNSHAPED GRANULAR FOUNDATION

SHAPED – For a shaped subgrade with granular foundation, the bottom of the excavation is shaped to conform to the pipe surface but at least 2 in. (50 mm) greater than the outside dimensions of the pipe. The width should be sufficient to allow 6/10 of the outside pipe diameter for circular pipe, 7/10 of the outside span for arch and elliptical pipe, and the full bottom width of box sections to be bedded in fine granular fill placed in the shaped excavation. Densely compacted backfill should be placed at the sides of the pipe to a depth of at least 12 in. (300 mm) above the top of the pipe.

UNSHAPED – A granular foundation without shaping is used only with circular pipe. The pipe is bedded in compacted granular material placed on the flat trench bottom. The granular bedding has

a minimum thickness, d , as listed and should extend at least halfway at the sides. The remainder of the side fills, and a minimum depth of 12 in. (300 mm) over the top of the pipe, should be filled with densely compacted material.

CLASS C BEDDING

SHAPED SUBGRADE OR GRANULAR FOUNDATION

SHAPED SUBGRADE – The pipe is bedded with ordinary care in a soil foundation, shaped to fit the lower part of the pipe exterior with reasonable closeness for a width of at least 50 percent of the outside diameter for a circular pipe, and 1/10 of the outside pipe rise for arch pipe, elliptical pipe and box sections. For trench installations the sides and area over the pipe are filled with lightly compacted backfill to a minimum depth of 6 in. (150 mm) above the top of the pipe. For embankment installations the pipe should not project more than 90 percent of the vertical height of the pipe above the bedding.

GRANULAR FOUNDATION – Used only with circular pipe, the pipe is bedded in compacted granular material or densely compacted backfill placed on a flat bottom trench. The bedding material should have a minimum thickness as indicated and should extend up the sides for a height of at least 1/6 the outside diameter. For trench installations the sidefill and area over the pipe to a minimum depth of 6 in. (150 mm) should be filled with lightly compacted backfill.

CLASS D BEDDING

Used only with circular pipe, little or no care is exercised either to shape the foundation surface to fit the lower part of the pipe exterior, or to fill all

spaces under and around the pipe with granular materials. However, the gradient of the bed should be smooth and true to established grade. This class of bedding also includes the case of pipe on rock foundations in which an earth cushion is provided under the pipe but is so shallow that the pipe, as it settles under the influence of vertical load, approaches contact with the rock.

EMBANKMENT BEDDING CIRCULAR PIPE (INCHES)

Notes:

For Class B and C beddings, subgrades should be excavated or over excavated, if necessary, so a uniform foundation free of protruding rocks may be provided.

Special care may be necessary with Class A or other unyielding foundations to cushion pipe from shock when blasting can be anticipated in the area.

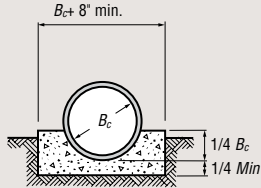

CONCRETE CRADLE CLASS A

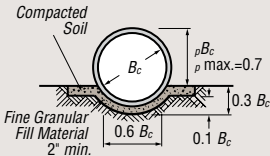

SHAPED SUBGRADE WITH GRANULAR FOUNDATION CLASS B

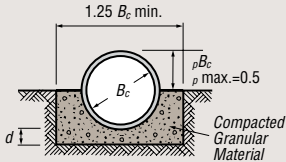

GRANULAR FOUNDATION CLASS B

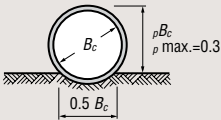

CLASS C

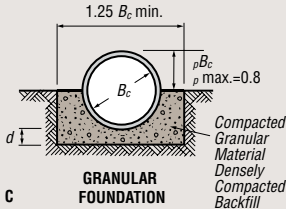

GRANULAR FOUNDATION CLASS C



FLAT SUBGRADE CLASS D

Depth of Bedding Material Below Pipe	
D	d(min)
27" & smaller	3"
30" to 60"	4"
66" & larger	6"

Legend

- B_c = outside diameter
- H = backfill cover above top of pipe
- D = inside diameter
- d = depth of bedding material below pipe

EMBANKMENT BEDDING CIRCULAR PIPE (MILLIMETERS)

Notes:

For Class B and C beddings, subgrades should be excavated or over excavated, if necessary, so a uniform foundation free of protruding rocks may be provided.

Special care may be necessary with Class A or other unyielding foundations to cushion pipe from shock when blasting can be anticipated in the area.

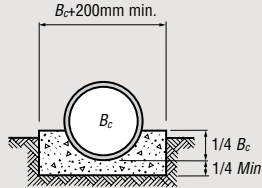

**CONCRETE CRADLE
CLASS A**

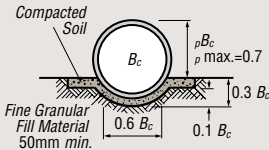

**SHAPED SUBGRADE WITH
GRANULAR FOUNDATION**

CLASS B

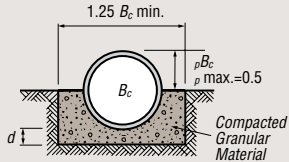

**GRANULAR
FOUNDATION**

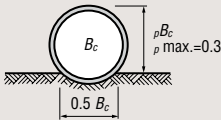

CLASS C

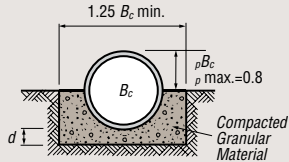

**GRANULAR
FOUNDATION**



**FLAT SUBGRADE
CLASS D**

Depth of Bedding Material Below Pipe	
D	d(min)
675mm & smaller	75mm
750mm to 1,500mm	100mm
1,650mm & larger	150mm

Legend

- B_c = outside diameter
- H = backfill cover above top of pipe
- D = inside diameter
- d = depth of bedding material below pipe

TRENCH BEDDING CIRCULAR PIPE (INCHES)

Notes:

For Class A bedding, use d as depth of concrete below pipe unless otherwise indicated by soil or design conditions. For Class B and C beddings, subgrades should be excavated or over excavated, if necessary, so a uniform foundation free of protruding rocks may be provided. Special care may be necessary with Class A or other unyielding foundations to cushion pipe from shock when blasting can be anticipated in the area.

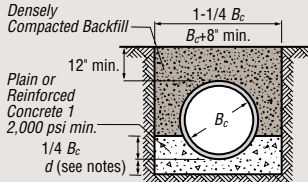

CONCRETE CRADLE

CLASS A

Reinforced $A_s = 1.0\%$ $B_f = 4.8$

Reinforced $A_s = 0.4\%$ $B_f = 3.4$

Plain $B_f = 2.8$

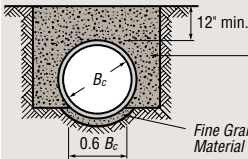

SHAPED SUBGRADE WITH GRANULAR FOUNDATION

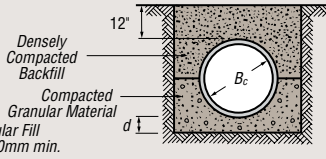

GRANULAR FOUNDATION

CLASS B

$B_f = 1.9$

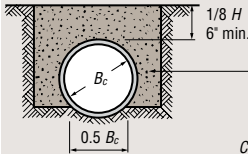

SHAPED SUBGRADE

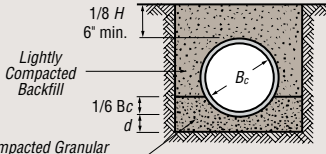

GRANULAR FOUNDATION

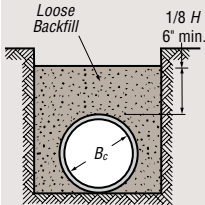

FLAT SUBGRADE

CLASS D

$B_f = 1.1$

Depth of Bedding Material Below Pipe	
D	d(min)
27" & smaller	3"
30" to 60"	4"
66" & larger	6"

Legend

B_c = outside diameter

H = backfill cover above top of pipe

D = inside diameter

d = depth of bedding material below pipe

A_s = area of transverse steel in the cradle of arch expressed as a percentage of area of concrete at invert or crown

TRENCH BEDDING CIRCULAR PIPE (MILLIMETERS)

Notes:

For Class A bedding, use d as depth of concrete below pipe unless otherwise indicated by soil or design conditions. For Class B and C beddings, subgrades should be excavated or over excavated, if necessary, so a uniform foundation free of protruding rocks may be provided. Special care may be necessary with Class A or other unyielding foundations to cushion pipe from shock when blasting can be anticipated in the area.

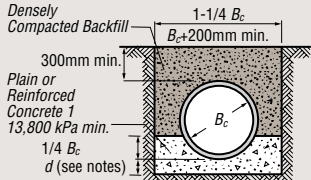

CONCRETE CRADLE

CLASS A

Reinforced $A_s = 1.0\%$ $B_f = 4.8$
 Reinforced $A_s = 0.4\%$ $B_f = 3.4$
 Plain $B_f = 2.8$

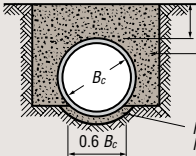

SHAPED SUBGRADE WITH GRANULAR FOUNDATION

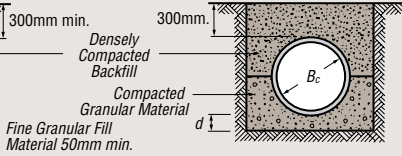

GRANULAR FOUNDATION

CLASS B

$B_f = 1.9$

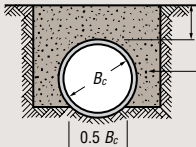

SHAPED SUBGRADE

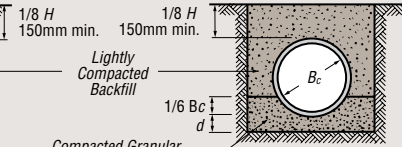

GRANULAR FOUNDATION

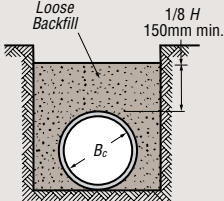

**FLAT SUBGRADE
CLASS D
 $B_f = 1.1$**

Depth of Bedding Material Below Pipe	
D	$d(\text{min})$
675mm & smaller	75mm
750mm to 1,500mm	100mm
1,650mm & larger	150mm

Legend

B_c = outside diameter
 H = backfill cover above top of pipe
 D = inside diameter
 d = depth of bedding material below pipe
 A_s = area of transverse steel in the cradle of arch expressed as a percentage of area of concrete at invert or crown

TRENCH BEDDINGS ELLIPTICAL & ARCH PIPE (INCHES)

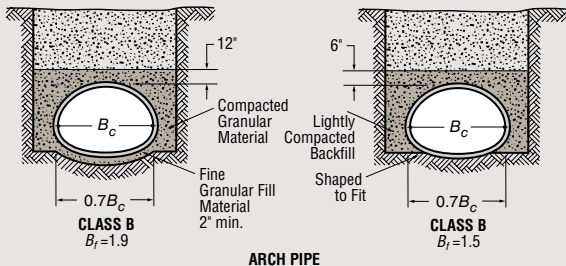
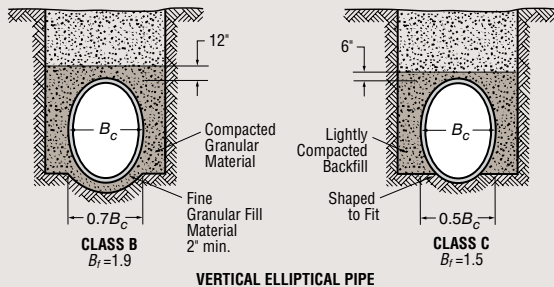
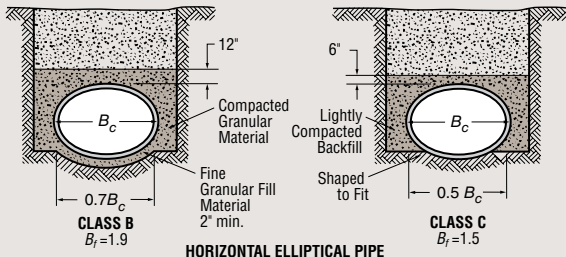

TRENCH BEDDINGS ELLIPTICAL & ARCH PIPE (MILLIMETERS)

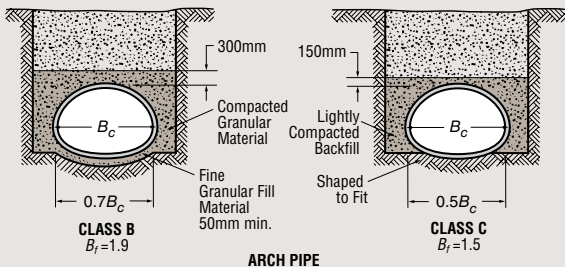
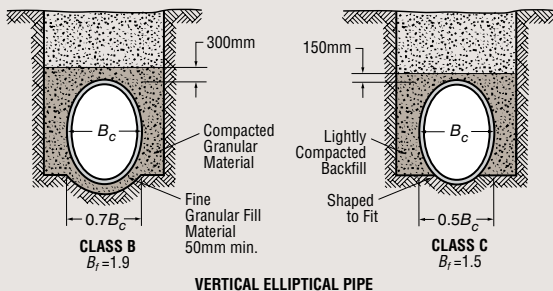
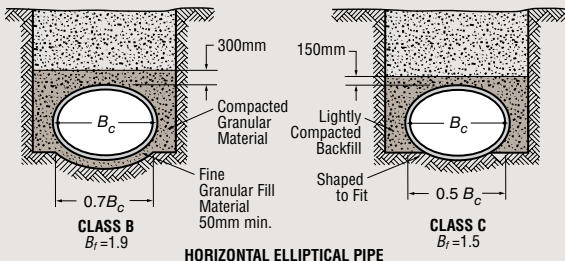

EMBANKMENT BEDDINGS ELLIPTICAL & ARCH PIPE (INCHES)

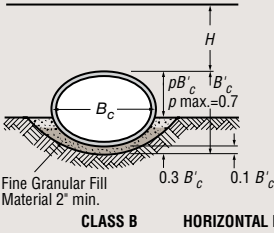

HORIZONTAL ELLIPTICAL PIPE

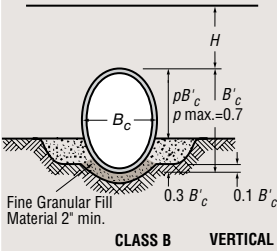
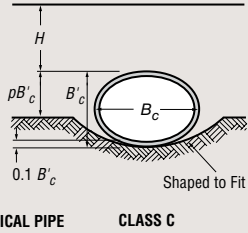

VERTICAL ELLIPTICAL PIPE

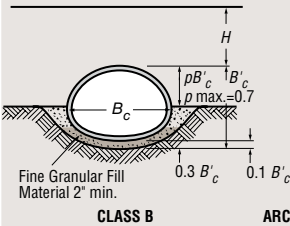
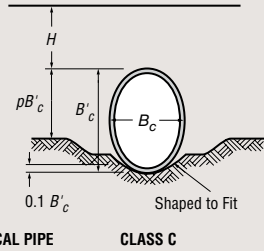

ARCH PIPE

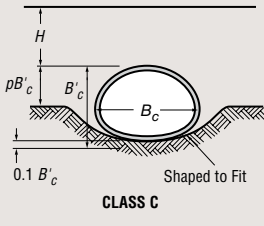

EMBANKMENT BEDDINGS ELLIPTICAL & ARCH PIPE (MILLIMETERS)

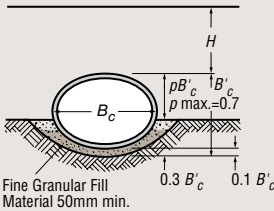

CLASS B

HORIZONTAL ELLIPTICAL PIPE

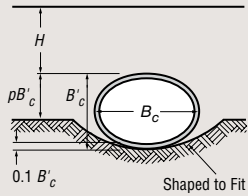

CLASS C

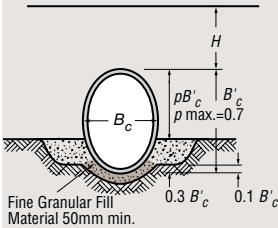

CLASS B

VERTICAL ELLIPTICAL PIPE

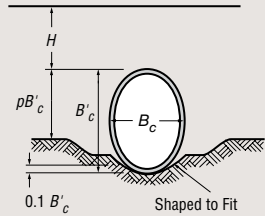

CLASS C

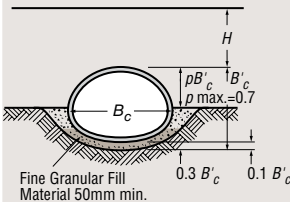

CLASS B

ARCH PIPE

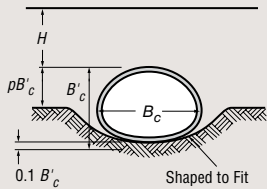

CLASS C

GASKET INSTALLATION

Jointing of concrete pipe is the process of connecting one pipe to another in order to create a pipe system. This is accomplished by homing the spigot of one pipe into the bell of another pipe.

Normal convention is to have pipe installation start at the outlet end of the line of pipe sections and work upstream. Similarly the bell end typically should point upstream and the spigot or tongue should point downstream. This helps prevent bedding material from being forced into the bell during jointing and enables easier coupling of pipe sections. However there are situations where it makes sense to either lay the pipe downstream to make the joint pushing the bell end onto the spigot or both. With proper installation practices of maintaining the required grade and careful homing of the pipe joint, concrete pipe or box culvert pipeline sections laid downstream, and with bell inserted into the spigot, will function identically to those sections laid the other way and should not be prohibited when site conditions dictate this installation method.

Several types of joints and sealant materials are utilized for precast concrete pipe, and maintenance structures, to satisfy a wide range of performance requirements. All of the joints are designed for ease of installation. Rubber gaskets are the most common sealant material and are used in sanitary and storm sewer systems to provide a soil and water tight joint.

Commonly used rubber gaskets include:

- Self-lubricating
- “O” Ring
- Roll-on
- Single Offset (Profiles)

CLEAN BELL

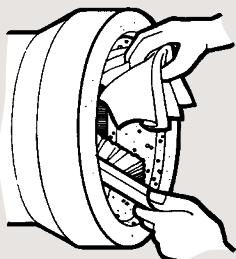

Carefully clean all dirt and foreign substances from the jointing surface of the bell or groove end of pipe.

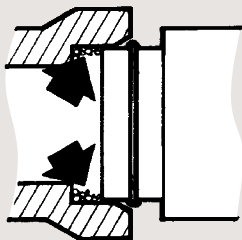

Improperly prepared bell jointing surface may prevent homing of the pipe.

CLEAN SPIGOT

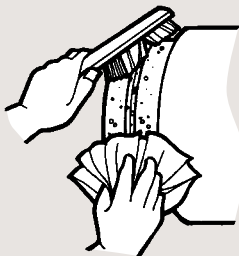

Carefully clean spigot or tongue end of pipe, including the gasket recess.

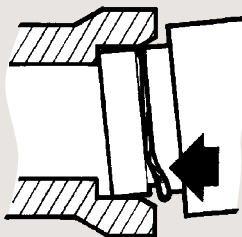

Improperly prepared spigot and gasket recess may prevent gasket from sealing correctly.

LUBRICATE BELL

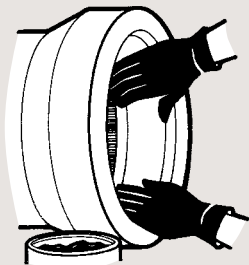

Lubricate bell jointing surface liberally. Use a brush, cloth, sponge or gloves to cover entire surface. Only approved lubricant should be used.

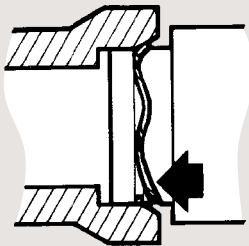

A bell not lubricated or improperly lubricated may cause gasket to roll and possibly damage the bell.

LUBRICATE SPIGOT



Lubricate the spigot or tongue end of pipe, especially the gasket recess.

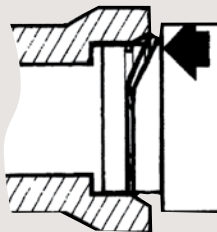

Gasket may twist out of recess if lubricant in recess is lacking or insufficient.

LUBRICATE GASKET



Lubricate the gasket thoroughly before it is placed on the spigot or tongue.

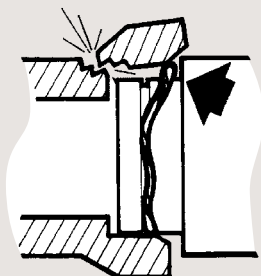

Excess force will be required to push the pipe to the home position if gasket is not well lubricated.

INSTALL GASKET

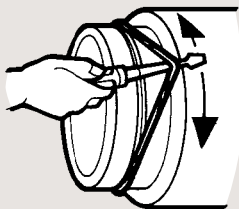

Fit the gasket carefully. Equalize the rubber gasket stretch by running a smooth, round object, inserted between gasket and spigot, around the entire circumference several times.

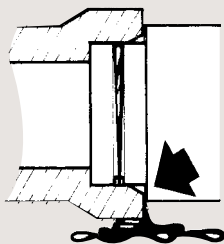

Unequal stretch could cause bunching of gasket and may cause leaks in the joint or crack the bell.

ALIGN PIPE

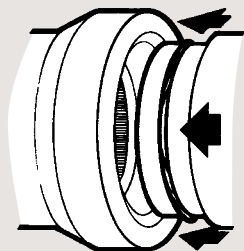

Align bell and spigot of pipes to be jointed. Before homing the joint, check that the gasket is in contact with the entry taper around the entire circumference.

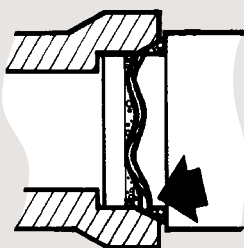

Improper alignment can dislodge gasket causing leaks or possibly break the bell.

Except for the roll-on and pre-lubricated types, the gasket and bell should be coated with a lubricant recommended by the manufacturer. The lubricant must be clean and be applied with a brush, cloth pad, sponge or glove. For “O” Ring gasket joints, the gasket recess must also be lubricated prior to the placement of the gasket.

Gaskets are required to be stored in a controlled environment at the manufacturer’s location, as well as on the job site. They need to be protected from prolonged exposure to sunlight, extreme heat in the summer, and extreme cold, snow and ice in the winter. Proper care of the gaskets prior to installation will ensure maximum ease of installation, and maximum sealing properties of the gaskets.

Gaskets are generally formulated for maximum sealing performance in a standard sewer installation carrying primarily storm water or sanitary sew-

age. Custom rubber formulations are available for special situations, where specific elements are being carried in the effluent which are deleterious to normal gasket materials. The rubber gaskets utilized in joints are required to meet ASTM C1619 and CAN/CSA A257.3 and the Plant Prequalification Program for Precast Concrete Drainage Products.

Note: The bell and spigot configurations are for illustrative purposes only. Actual bell and spigot configurations may differ based on the manufacturer.

“O” RING GASKETS

Step 1: Ensure the bell, spigot and gasket for the joint are clean and free of debris or burrs.

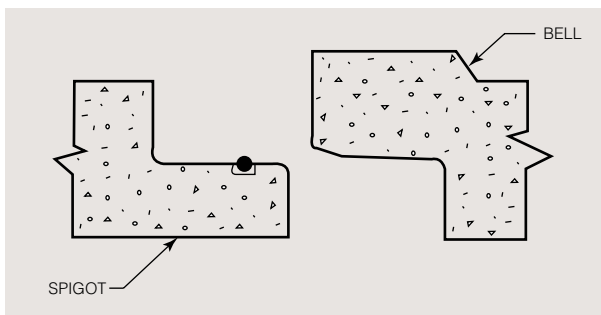

Step 2: Using the lubricant supplied, lubricate the “O” ring groove in the spigot of the pipe to be homed.

Step 3: Lubricate the gasket thoroughly. Place the gasket in the lubricated groove. Equalize the “O” ring around the spigot by running a screwdriver under the profile around the perimeter of the spigot a couple of times. This process will allow the stretch of the “O” ring to be spread out evenly around the spigot.

Step 4: Thoroughly lubricate the gasket seating area of the spigot and entire bell of the receiving pipe including the entrance bevel or flared end area.

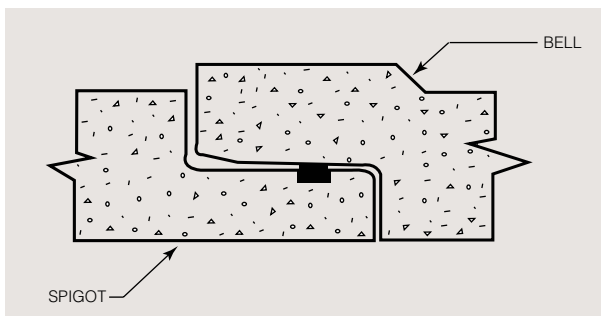

Step 5: Align the spigot with the bell ensuring that the gasket is in contact with the flared end of the bell around the complete circumference of the pipe, and apply a uniform force to home the joint.

SELF-LUBRICATING GASKETS

DO NOT USE LUBRICANT

Step 1: Ensure the bell, spigot and gasket for the joint are clean and free of debris and burrs.

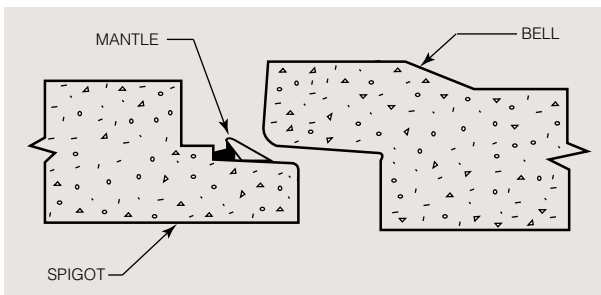

Step 2: Place self lubricating gasket on the spigot end of the joint, with the mantle (tube) towards end of spigot. The gasket must be seated against the spigot shoulder. Please note that no equalization of the gasket is required

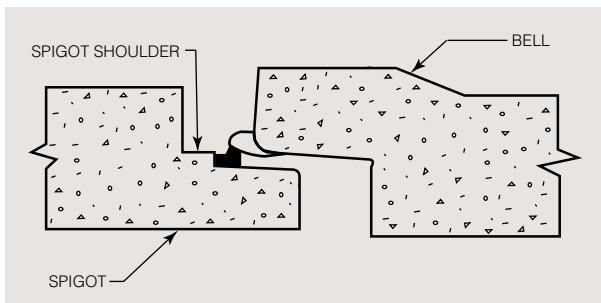

Step 3: Align the spigot with the bell and home the joint. When applying the homing force ensure the pipes are level to each other and the spigot section is not tilted and “rolled” into the bell. When the joint is homed, the mantle (tube) section slides over the compression area of the gasket and comes to rest on the spigot shoulder.

ROLL-ON GASKETS

DO NOT USE LUBRICANT

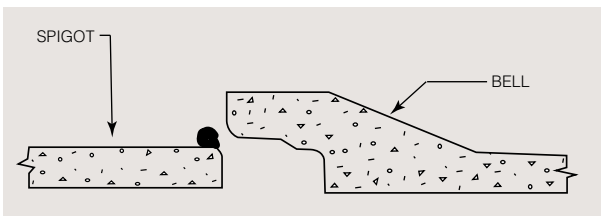

- Step 1: Ensure the bell, spigot and gasket for the joint are clean and free of debris and burrs.
- Step 2: Place roll-on gasket on the spigot end of the pipe, with the gasket protrusion on the leading edge of the spigot.

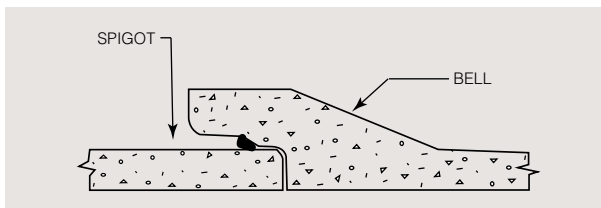

- Step 3: Align the spigot with the bell and apply a uniform force to home the joint NOTE: If this procedure is followed, the spigot will be heard striking the bell when the gasket rolls over.

Mastic

Mastic sealants consist of rubber compounds or bitumen and inert mineral filler, which are usually applied at ambient temperatures. The joint surfaces are thoroughly cleaned, dried and prepared in accordance with the manufacturer's recommendations. A sufficient amount of sealant should be used to fill the annular joint space with some squeeze out. During cold weather, better workability of the mastic sealant can be obtained if the mastic and joint surfaces are warmed.

Mortar

Mortar consists of portland cement paste, sand and water. The joint surface is thoroughly cleaned and soaked with water immediately before the joint is made. A layer of paste or mortar is placed in the lower portion of the bell or groove end of the installed pipe and on the upper portion of the tongue

or spigot end of the pipe section to be installed. The tongue or spigot is then inserted into the bell or groove of the installed pipe until some mortar is squeezed out. Any annular joint space between the adjacent pipe ends is filled with mortar and the excess mortar on the inside of the pipe wiped and finished to a smooth surface.

Geotextile Filter Fabrics

As an alternative measure, where groundwater and joint configurations warrant, a band of geotextile filter fabric, usually 1 to 2 feet (.3 to .6 meters) wide may be wrapped around the exterior of the pipe joint and secured with either tape or stitching to prevent soil infiltration into joints of storm and culvert pipe.

External Bands

Portland cement mortar bands are sometimes specified around the exterior of the pipe joint. A slight depression is excavated in the bedding material to enable mortar to be placed underneath the pipe. The entire external joint surface is then cleaned and soaked with water. Special canvas or cloth diapers can be used to hold the mortar as it is placed. Backfill material should be immediately placed around the pipe.

Rubber-mastic bands also can be used around the exterior of the pipe joint. The bands are stretched tightly around the barrel of the pipe and held firmly in place by the weight of the backfill material.

JOINT PROCEDURES

Joints for pipe sizes up to 24 in. (600 mm) in diameter can usually be assembled by means of a bar and wood block. The axis of the pipe section to be installed should be aligned as closely as possi-



When jointing small diameter pipe, a chain or cable is wrapped around the barrel of the pipe a few feet behind the tongue or spigot and fastened with a grab hook or other suitable connecting device. A lever assembly is anchored to the installed pipe, several sections back from the last installed section, and connected by means of a chain or cable to the grab hook on the pipe to be installed. By pulling the lever back, the tongue or spigot of the pipe being jointed is pulled into the bell or groove of the last installed pipe section. To maintain close control over the alignment of the pipe, a laying sling can be used to lift the pipe section slightly off the bedding foundation.

When jointing larger diameter pipe, when granular bedding is used, mechanical pipe pullers are required. Several types of pipe pullers or come-along devices have been developed but the basic force principles are the same. Large diameter pipe can be jointed by placing a *dead man blocking* inside the installed pipe, several sections back from the last installed section, which is connected by means of a chain or cable to a strong back placed across

the end of the pipe section being installed. The pipe is pulled home by lever action similar to the external assembly.

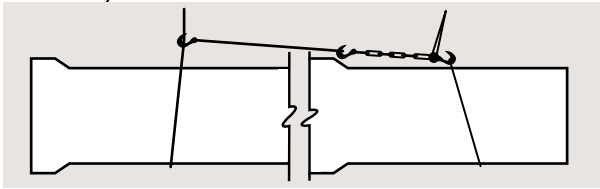

Mechanical details of the specific apparatus used for pipe pullers or come-along devices may vary, but the basic lever action principle is used to develop the necessary controlled pulling force.

The use of excavating equipment to push pipe sections should be done with extreme caution. The force applied by such equipment can damage the pipe. Direct contact between installation machinery and the pipe is prohibited. Use appropriate cushion material between the pipe and the machine to prevent spalling.

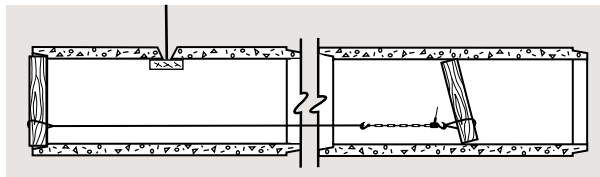

SERVICE CONNECTIONS

When a pipe connects to a rigid structure such as a building, manhole or junction chamber, the bedding and foundation for the connecting pipe section should be highly compacted to minimize differential settlement. Differential settlement can result in the pipe being sheared or cracked at the connection. Special connectors are available which provide flexibility between the connecting pipe and the structure.

CURVED ALIGNMENT

Changes in direction of sewer lines are usually accomplished at manhole structures, while grade and alignment changes in concrete pipe sewers can be incorporated into the line through the use of deflected straight pipe, radius pipe or specials. Since manufacturing and installation feasibility are dependent on the particular method used to negotiate a curve, it is important to establish the method prior to trench excavation. For deflected straight pipe the joint of each pipe section is opened up on one side while the other side remains in the home position. The difference between the home and opened joint space is generally designated as the pull. The maximum permissible pull must be limited to that opening which will provide satisfactory joint performance. This varies for different joint configurations and is best obtained from the pipe manufacturer.

Radius pipe, also referred to as beveled or mitered pipe, incorporates the deflection angle into the pipe joint. The pipe is manufactured by shortening one side of the pipe. The amount of shortening for any given pipe is dependent on manufacturing feasibility. Because of the possibility of greater deflection angles per joint, sharper curvature with correspondingly shorter radii can be obtained with radius pipe than with deflected straight pipe.

When establishing alignment for radius pipe, the first section of radius pipe should begin within one half of a radius pipe length of the point of curvature, and the last section of the radius pipe should extend one half of a radius pipe length beyond the point of tangent, as shown in the illustration *Alignment for Radius Pipe*.

CURVED ALIGNMENT

Deflected Straight Line

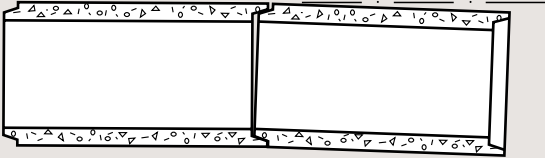

Radius Pipe

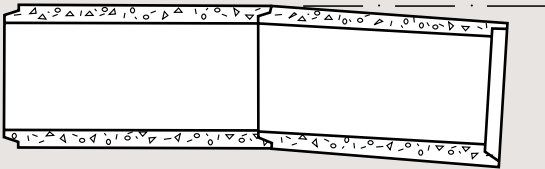

Bends

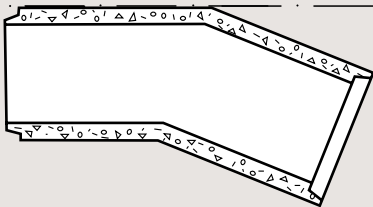

ALIGNMENT FOR RADIUS PIPE

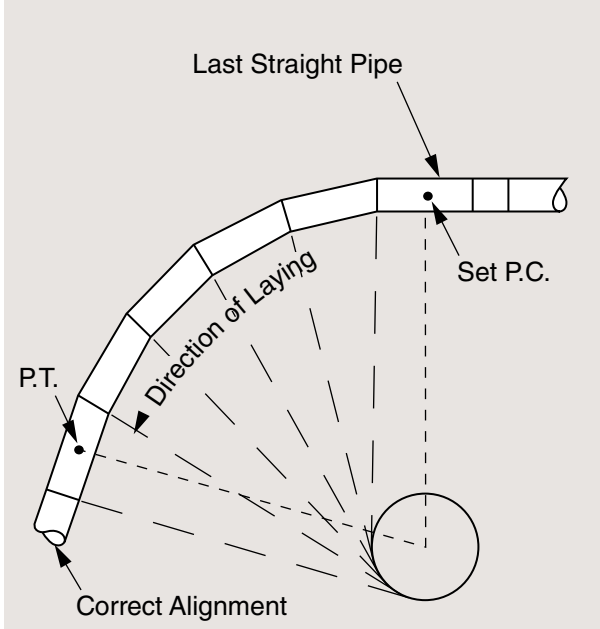

Special precast sections can be used for extremely short radius curves which cannot be negotiated with either deflected straight pipe or with conventional radius pipe. Sharper curves can be handled by using special short lengths of radius pipe rather than standard lengths.

One or more of these methods may be employed to meet the most severe alignment requirements. Since manufacturing processes and local standards vary, local concrete pipe manufacturers should be consulted to determine the availability and geometric configuration of pipe sections to be installed on curved alignment. In addition, many manufacturers have standardized joint configurations and deflec-

tions for specific radii and economies may be realized by using standard pipe.

When radius pipe is used to negotiate a curve, the point of curve (P.C.) should be established at the midpoint of the last straight pipe and the point of tangent (P.T.) falls one-half of the standard pipe length back from the straight end of the last radius pipe. Incorrect alignment will result when the point of curve is established at the end of the last section of straight pipe. To assure the point of curve is at the proper station it may be necessary for a special short length of pipe to be installed in the line ahead of the point of curve.

FLOWABLE FILL

The use of flowable fill can reduce construction concerns and costs associated with poor in-situ soils that would otherwise require expensive imported embedment materials, limited space, or lower strength pipe materials. The benefits in ease of construction do not come without due diligence in the design of the installation. When flowable fill is used it is not only important that the material is manufactured and placed appropriately, but that appropriate design issues related to the quality of the pipe and in-situ soil material are taken into account when establishing the soil-pipe structure.

The method of placing the material is important because the strength and longevity of the pipe depend on the uniformity of the filler. Non-uniformity means that pressure points could form, reducing the lifetime of the pipe. One method of placing the flowable fill is to raise the pipe on two sand bags so that there are gaps under the pipe. Then allow the fill to flow under the pipe until the fill is seen on both sides of the pipe. After filling in the gaps between

the insitu soil and the pipe, the fill can be vibrated as necessary (if the fill bleeds excessively or when the mix is stiffer, 8-10in slump, rodding is necessary). Many times it is impractical to lay the pipe on two sand bags; in this case the pipe can be laid directly on the trench bottom. Because, in this case, there is not enough space under the pipe for the flowable fill to flow, visual inspection must suffice in determining if the flowable fill is filling in all the gaps.

FINAL BACKFILLING

Once the envelope of backfill material is placed and properly compacted, the remainder of the fill or backfill should be placed and compacted to prevent settlement at the surface. Several types of compaction equipment are available and certain types are best for particular types of soils. The steel wheeled roller is best suited for compacting coarse aggregate such as slag, coarse gravel and graded rock aggregates. The sheepsfoot roller is best for cohesive clays or silts, but is not suitable for use on granular soils. Specially designed rubber tired rollers, which provide both static weight and kneading action, are applicable to many soils from clays to sand.

When impact or vibratory equipment is used for compaction, care shall be taken to avoid damaging the pipe, particularly for installations with less than 2 feet of earthfill over the pipe. Contractor shall demonstrate to the satisfaction of the Engineer that his installation process will not result in damage to the pipe. Compaction stresses generated by vibratory compaction equipment vary with the type of equipment used and tend to decrease as the pipe diameter increases. For most installations, two feet of earth fill over the top of the pipe is sufficient to

adequately distribute compaction forces to the surrounding soil mass.

Regardless of the type of compaction equipment used, the backfill or fill material should be consistent with density requirements of the particular bedding specified.

ACCEPTANCE TESTS

The physical tests included in the material specifications, under which the pipe is purchased, assure that pipe delivered to the job site meets or exceeds the requirements established for a particular project. The project specifications usually include acceptance test requirements to assure that reasonable quality control of workmanship and materials has been realized during the construction phase of the project. Soil density, line and grade, and visual inspection are all applicable tests for all storm sewer, sanitary sewer and culvert projects. For sanitary sewers, limits are usually established for infiltration and exfiltration.

SOIL DENSITY

Several test procedures have been developed for measuring in-place soil densities. For cohesive soils most of the methods are based on volumetric measurement. To correlate in-place soil densities with the maximum density of a particular soil, it is first necessary to determine the optimum moisture content for maximum compaction and then use this as a guide to determine the actual compaction of the fill or backfill. The most common methods used to determine optimum moisture content and maximum density are the standard tests for moisture-density relations, frequently termed Standard Proctor Test and Modified Proctor Test.

ASTM and AASHTO Specifications related to soil density and moisture content are:

ASTM D 698
ASTM D 1557
ASTM D 2922

AASHTO T 99
AASHTO T 180
AASHTO T 238

MOISTURE-DENSITY TEST

STANDARD

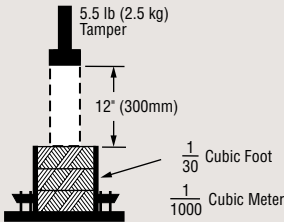

MODIFIED

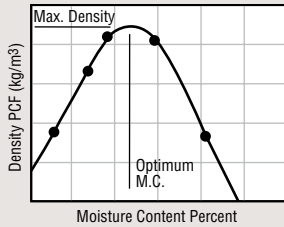
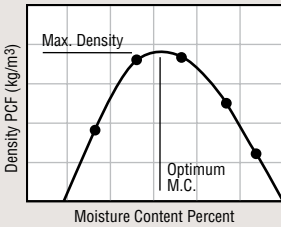
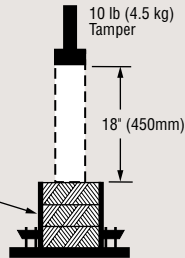

FIELD DENSITY TEST

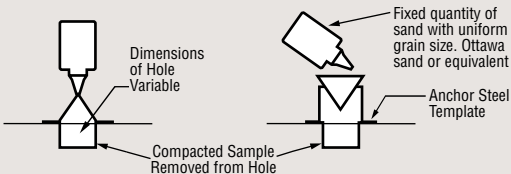

DETERMINATION OF VOLUME OF REMOVED SAMPLE

LINE AND GRADE

Line and grade should be checked as the pipe is installed, and any discrepancies between the design and actual alignment and pipe invert elevations should be corrected prior to placing the backfill or fill over the pipe. Obtaining manhole invert levels for the preparation of as-built drawings, combined with visual inspection of the sewer or culvert, provides an additional check that settlement has not occurred during backfill or fill operations.

VISUAL INSPECTION

Larger pipe sizes can be entered and examined while smaller sizes must be inspected visually from each manhole or by means of TV cameras. Following is a checklist for an overall visual inspection of a sewer or culvert project:

- debris and obstructions
- excessive cracks
- joints properly sealed
- invert smooth and free of sags or high points
- stubs properly grouted and plugged
- hookups, diversions and connections properly made
- catch basins and inlets properly connected
- manhole frames and covers properly installed
- surface restoration and all other items pertinent to the construction properly completed.

INFILTRATION

The infiltration of excessive ground water into a sanitary sewer can overload the capacity of a sewer collection system and treatment facilities. The infiltration test, conducted in accordance with ASTM C 969 (C 969M), is intended to demonstrate the integrity of the installed materials and construction

procedures, as related to the infiltration of ground water, and therefore, is only applicable if the water table level is at least 2 ft. (600 mm) above the crown of the pipe for the entire length of the test section. Although the test is a realistic method of determining water tightness, there are inherent difficulties in applying the test criteria because of seasonal fluctuations in the water table and the problem of correlating high ground water level conditions with actual test conditions.

Before conducting the test, the water table should be allowed to stabilize such that water completely surrounds the pipe during the test period. The test is usually conducted between adjacent manholes with the upstream end of the sewer bulkheaded in a suitable manner to isolate the test section. All service laterals, stubs and fittings should be properly plugged or capped at the connection to the test pipe section to prevent the entrance of ground water at these locations. A V-notch weir or other suitable measuring device should be installed in the inlet pipe to the downstream manhole. Infiltrating water is then allowed to build up and level off behind the weir until steady-uniform flow is obtained. When steady flow occurs over the weir, leakage is determined by direct reading from graduations on the weir or converting the flow quantity to gallons per unit length of pipe per unit of time.

An important factor in applying the test criteria is to properly account for the variable water head over the length of sewer being tested. The downstream end of the test section will often be subjected to a greater external water pressure than the upstream end. To compensate for this variable external pressure, the test pressure should be that pressure corresponding to the average head of water over the

INFILTRATION TEST

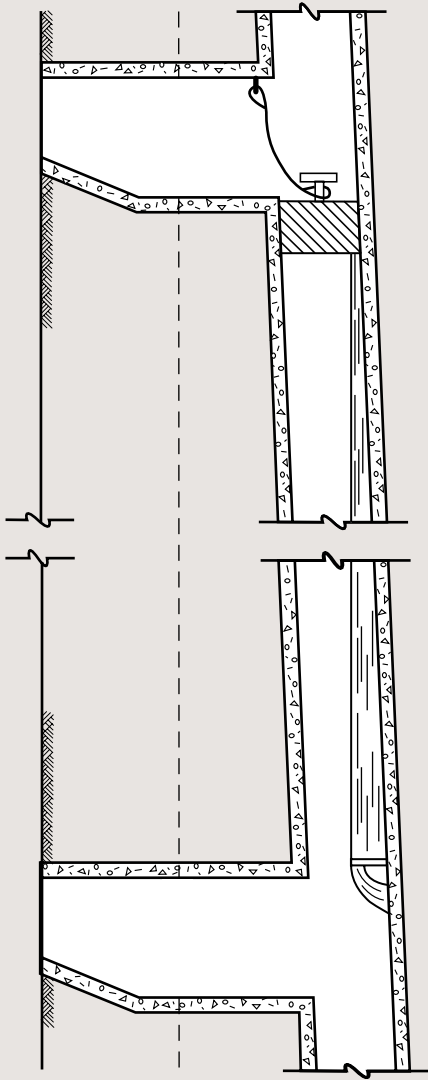

test section. Certain test sections may exceed the allowable infiltration, limits, but the average infiltration for the total project should be within the leakage limits established for the particular project. The effect of increased depth of groundwater on infiltration allowances must be considered. An average head of 6 ft. (1.8 m) of groundwater over the pipe is established as the base head. With heads of more than 6 ft. (1.8 m), the infiltration limit is increased by the ratio of the square root of the actual average head to the square root of the base head. For example, with an average groundwater head of 12 ft. (3.7 m), the 200 gallons per inch (18.5 liters per mm) of diameter per 1.0 mile (1.67 km) of pipe per day infiltration limit should be increased by the ratio of the square root of the actual average head, 12 ft. (3.7 m), to the square root of the base head 6 ft. (1.8 m), which results in an allowable infiltration limit of 282 gallons per inch (26.2 liters per mm) of diameter per mile (km) of pipe per day.

EXFILTRATION

The exfiltration test is used in lieu of the infiltration test for small diameter sewers where individual joints cannot be tested. Although actual infiltration will normally be less than that indicated by the water exfiltration test, the test does provide a positive method of subjecting the completed sewer system to an actual pressure test. Since sanitary sewers are not designed or expected to operate as a pressure system, care must be exercised in conducting the test and correlating the results with the allowable exfiltration limits.

The test is usually conducted between adjacent manholes in accordance with ASTM C 969M (C 969). Prior to the test, all service laterals, stubs and

fittings within the test section should be plugged or capped and adequately braced or blocked to withstand the water pressure resulting from the test. If manholes are to be included in the test, the inlet pipe to each manhole should be bulkheaded and the test section filled with water through the upstream manholes. To allow air to escape from the sewer, the flow should be at a steady rate until the water level in the upstream manholes is at the specified level above the crown of the pipe. If necessary, provisions should be made to bleed off entrapped air during the filling of the test section. Once the test section is filled the water should be allowed to stand for an adequate period of time to allow water absorption into the pipe and manhole. After water absorption has stabilized, the water level in the upstream manhole is brought up to the proper test level. This level is established by measuring down from the manhole cover or other convenient datum point.

After a set period of time, the water elevation should be measured from the same reference point and the loss of water during the test period calculated, or the water can be restored to the level existing at the beginning of the test, and the amount added used to determine the leakage.

To exclude both manholes from the test, it is necessary to bulkhead the outlet pipe of the upstream manhole. Provisions must be made in the bulkhead for filling the pipe and expelling trapped air.

ASTM C 969 (C 969M) recommends the water level at the upstream manhole to be a minimum of 2 ft. (600 mm) above existing groundwater, or 2 ft. (600 mm) above the crown of the upstream pipe, whichever is greater. Since a sewer is installed on a grade, the test section downstream will be sub-

EXFILTRATION TEST

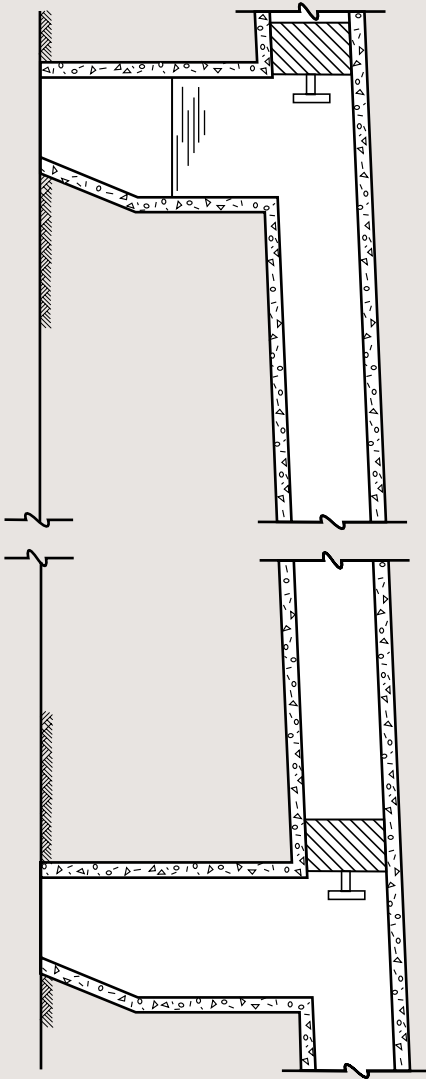

jected to greater pressure. When the average head on the test section is greater than 3 ft. (900 mm), the allowable exfiltration limit should be adjusted in direct relationship to the ratio of the square root of the average test head to the square root of the specified base head, 3 ft. (900 mm).

The measured leakage of any individual section tested may exceed the leakage allowance specified, provided the average of all sections tested does not exceed the specified leakage allowance.

AIR TESTING

The low-pressure air test conducted in accordance with ASTM C 924 (C 924M) is a test, which determines the rate at which air under pressure escapes from an isolated section of sewer. The rate of air loss is intended to indicate the presence or absence of pipe damage and whether or not the joints have been properly constructed. The test is not intended to indicate water leakage limits as no correlation has been found between air loss and water leakage. The section of pipe to be tested is plugged at each end by means of inflatable stoppers. The ends of all laterals, stubs and fittings to be included in the test should be plugged to prevent air leakage, and securely braced to prevent possible blow-out due to internal air pressure. One of the plugs should have an inlet tap, or other provision for connecting a hose to a portable air control source. The air equipment should consist of necessary valves and pressure gauges to control the rate at which air flows into the test section and to enable monitoring of the air pressure within the test section.

Air is added to the test section until the internal air pressure is raised to a specified level and allowed to stabilize with the temperature of the pipe

walls. The test is conducted by the pressure drop method, whereby, the air supply is disconnected and the time required for the pressure to drop to a certain level is determined by means of a stopwatch. This time interval is then used to compute the rate of air loss. In applying low-pressure air testing to sanitary sewers intended to carry fluid under gravity conditions, several important factors should be understood and precautions followed during the test:

- the air test is intended to detect defects in construction and pipe or joint damage and is not intended to be a measure of infiltration or exfiltration leakage under service conditions, as no correlation has been found between air loss and water leakage.
- air test criteria are presently limited to concrete pipe 24 in. (600 mm) in diameter and smaller by ASTM C924 (C 924M). Additional data is required to confirm the safety and applicability or develop criteria for pipe larger than 24 in. in diameter.
- plugs should be securely braced to prevent the unintentional release of a plug which can become a high velocity projectile. Plugs should not be removed until all air pressure in the test section has been released.
- for safety reasons, no one should be allowed in the trench or manhole while the test is being conducted.
- the testing apparatus should be equipped with a pressure relief device to prevent the possibility of loading the test section with the full compressor capacity

AIR TEST

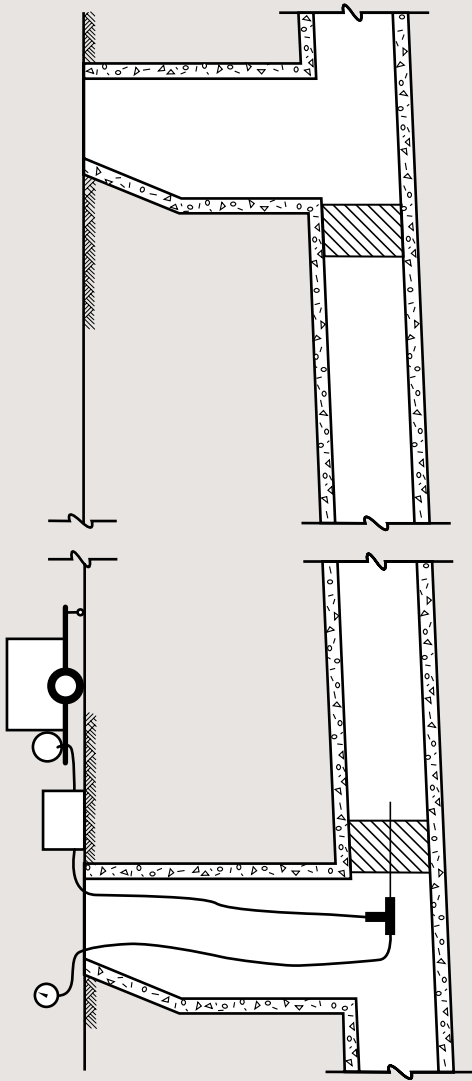

VACUUM TESTING

The vacuum (negative air pressure) test is governed by ASTM C 1214 (C 1214M) for pipe and C 1244 (C 1244M) for manholes. This test involves removing air from the pipe or manhole to a specified pressure less than atmospheric. The ability to hold a vacuum or a slow drop indicates an acceptable pipe or manhole. This test is not quantitative but provides economical testing of large samples. Other benefits include the inherent safety and economy of vacuum systems over pressurized systems.

This test method for pipe covers 4 to 36 in. (100 mm to 900 mm) diameter circular concrete pipe sewer lines utilizing gasketed joints and may be performed in the field or at the plant as a preliminary test. The ends of all laterals, stubs, and fittings should be plugged to prevent air leakage. Air is evacuated from the pipeline until a specified negative air pressure is reached. The drop in vacuum during the test period is recorded. The vacuum loss in cubic feet per minute (cubic meters per second) is calculated and compared to the allowable value.

JOINT TESTING-AIR

Joint testing according to ASTM C 1103 (C 1103M) may be performed on installed precast concrete pipe sewer lines, using either air or water under low pressure to demonstrate the integrity of the joint and the construction procedures.

When using either air or water, the joint to be tested is covered on the inside of the pipe by a ring with two end element sealing tubes. Prior to this the interior joint surface of the pipe should be cleaned and wetted. The joint test apparatus should be placed inside the pipe with the end element sealing tubes straddling both sides of the joint. Inflate end

element sealing tubes with air in accordance with equipment and manufacturer's recommendations.

For the joint air test, the void volume should be pressurized to a specified pressure greater than the pressure exerted by groundwater above the pipe. Allow the air pressure and temperature to stabilize, then shut off the air supply and start testing. The pressure should drop less than the allowable specified pressure drop. If the joint being tested fails, it may be repaired and retested.

When performing the joint water test, the bleed-off petcock must be located at top dead center of the pipe. Introduce water into the void volume until the water flows evenly from the open petcock. Close the petcock and pressurize the void to a specified pressure above the groundwater pressure. Shut off the water supply. The pressure should drop less than the allowable specified pressure drop. If the joint being tested fails, it may be repaired and retested.

JOINT TESTING-WATER

Conducting exfiltration tests on large pipe is usually not practical because of the considerable quantity of water required. If the pipe is large enough to be entered, each individual joint can be visually inspected, and if necessary, subjected to a water exfiltration test by means of test apparatus specially designed for this purpose. In this procedure, the joint is isolated with an expanding shield equipped with gaskets, which fit tightly against the pipe walls on each side of the joint being tested. Through appropriate piping, water is introduced into the annular space isolated by the shield and the leakage measured. The allowable leakage for individual joints is that which would occur on the basis of the allowable water leakage for one pipe section.

MULTIPLE PIPE INSTALLATIONS

A multiple pipe installation is the placement of two or more pipelines in a single trench or embankment condition. This installation procedure is most commonly used where restrictive cover requirements preclude the use of a single pipe of larger diameter or where an assembly of pipes is used to create a buried storm water storage system.

Although multiple pipe installations are common, the determination of pipe loads may present unusual problems. It should be noted that the pipe spacing and how the pipes are installed can have a significant effect on the design of the culverts. Refer to chapter four of the Concrete Pipe Design Manual for design procedures to the installations noted below.

FLAT TRENCH

For most cases, it is more practical to install multiple pipelines in a single, wide trench rather than using an individual trench for each line. Because of this, the trench is extraordinarily wide, and a positive projecting embankment installation most closely represents the actual loading on the pipes.

Standard Installations have specific compaction requirements for the soil in the haunch and lower side zones in each installation. The designer must provide adequate space between the pipelines that is appropriate for the method of compaction of the soil in the haunch and lower side zones. The optimum construction sequence is to place the bedding to grade; install the pipe to grade; compact the bedding outside the middle-third of the pipe; and then place and compact the haunch zone up to the springline of the pipe. Because compaction of the

soil in the space between multiple pipelines will be difficult in most cases, special care should be exercised by the designer when selecting the type of installation and bedding material for flat multiple pipeline installations.

The middle-third of bedding area under each pipeline is loosely placed uncompacted bedding. The intent is to maintain a slightly yielding bedding so the pipe may settle into the bedding and achieve improved load distribution. To effectively compact the soil in the haunch zone, it may be necessary to increase the clear spacing between pipes beyond the usual pipe OD/6.

BENCHED TRENCH

Another common type of multiple pipeline installations is where the pipe is separated vertically as well as horizontally. Generally, the criteria established by the local jurisdiction will require minimum vertical and horizontal separations between the pipelines, and possibly the minimum dimension of Y in respect to X.

A benched trench installation includes more complex design variables to consider than does the flat trench. The economy of a common excavation, or restricted trench width, is the principle reason for using the benched trench installation. Dead Loads on the pipelines may resemble either a Standard Installations trench or positive projecting embankment installation. Construction of a benched installation trench is frequently made in one of two following sequences;

- For the first method, the lower pipeline is installed in a conventional trench and the trench is back-filled and compacted to the foundation elevation of the upper pipeline. If any portion of the pipe installation cross-section of the upper pipeline is within

the side slope of the trench, the backfill material in the trench must be uniformly compacted to specified SIDD installation requirements.

- In the second method, the lower pipeline is installed in a conventional trench and the trench is backfilled to the foundation elevation of the upper pipeline. When the horizontal alignment of the upper pipeline is entirely outside the side slope of the trench of the lower pipeline, a bench is excavated at the foundation elevation of the upper pipeline.

In moderate trench width conditions, as is typically found in the lower pipeline, the resulting earth load is equal to the weight of the soil within the trench minus the shearing or frictional forces on the sides of the trench.

As the trench width increases, the reduction in the load from frictional forces is offset by the increase in the soil weight in the trench. As the trench width increases it starts to behave as an embankment and eventually, the embankment condition is reached when the trench walls are too far away from the pipe to help support the soil immediately adjacent to it. This is the transition width of the trench, where the trench load equals the embankment load. Any pipe designed in a trench width equal to or greater than the transition width should be designed as an embankment condition.

II. BOX CULVERT INSTALLATION MANUAL

INTRODUCTION

With the development of national standards for design and manufacturing, box culverts are rapidly becoming a large part of the precast industry. One of the unique benefits of precast concrete boxes is their fast and easy installation, even under adverse field and weather conditions. Precast boxes, like concrete pipe, can be custom fabricated to any configuration needed or desired in the field. Where larger waterway capacity is required, multiple sections can be placed side-by-side or connected in rows to provide an excellent storm water detention system for areas with outfall flow restrictions or requirements for on-site detention.

This manual presents a guide for the proper installation of concrete box culverts. While focusing on the construction of the box-soil system, this manual also addresses those factors critical to the completion of the entire system, from delivery of the box culverts to the jobsite, to the acceptance of the installed box line.

This manual is intended as a guide and is not to supersede the project specifications.

PRE-INSTALLATION

PRECAUTIONS

The Safety and Health Regulations for Construction under the Department of Labor, Occupational Safety and Health Administration (OSHA), are published federal regulations covering safety measures for all types of construction, including sewer and box culvert installations. All prime contractors and subcontractors are subject to these regulations when involved in any type of construction, including alterations and repair work. Installers should be aware of these regulations.

Reviewing proper installation practices, while considering the engineer's design assumptions (in relation to the use of trench boxes and backfill compaction requirements) will help to ensure worker safety as well as culvert longevity.

ORDERING, RECEIVING & HANDLING

Although the contractor is ordering the product, both the engineer and the supplier should be aware of the proposed schedule of the contractor. Coordination between the three parties will prevent unnecessary delays. Much of the time the manufacturer stocks a wide range of box sizes for varied depths. However, manufacturing facilities must frequently adapt to meet job requirements. Therefore, for special box types and large orders, prior knowledge will assist in correct and on-time delivery. When ordering box culverts, specifications should be in writing and should include:

- Specification designation
- Name and location of project
- Box size, laying length and the bury depth
- Total footage of each type and size of box

- Design live load
- Type of joint
- List of fittings
- Material test requirements
- Joint material and quantity
- Invoicing instructions

The following information should be clearly marked on each box section:

- Specification designation
- Minimum and maximum bury depth
- Span, rise, table number, top of box and design earth cover for ASTM C 1433 (Standard), C 1577 (LRFD)
- Date of manufacture
- Name or trademark of the manufacturer

SCHEDULING / UNLOADING / PLACING / SEQUENCE

It is important to be prepared for the delivery of every box. The proper machinery should be available to handle the unloading and placing of each section. Each shipment is tied down to avoid damage during transport. However, it is the responsibility of the contractor to make certain no damage has occurred during transit. An overall inspection should be performed upon arrival of the boxes. Before unloading, the delivered box should be checked against the order invoice to ensure accurate delivery of all items.

If a box has been damaged it should be set aside and recorded to ensure its proper order in the installation sequence. In some cases damaged ends, chips and cracks, which do not pass through the wall, can be repaired on site, while others are irreparable and may have to be returned to the supplier for replacement.

When unloading boxes, caution should be exercised to ensure no personnel are in the path of the box as it is being moved. The box should be handled per manufacturer's recommendations. Use only manufacturer approved lifting devices to handle box culvert sections. The box should be lifted and never dragged to avoid damage. If the lifting device could chip the box, padding should be provided between the box and the lifting mechanism.

When a box is provided with lifting holes, the lifting device should pass through the wall and distribute the weight along the inside wall of the box.

If the box is going to be installed directly from the truck trailer to the final location, a crane with stabilizers should be used. Be aware that some crawlers without outriggers, or backhoes, may not have the stability or maneuverability needed to line up the units for proper installation.

If the box is going to be stored on-site, alternative means can be used to transport the sections to their temporary location. Care must be taken at all times and handling of boxes should be limited. The manufacturer's handling recommendations should be followed at all times. Mishandling can result in cracked bells and spigots.

Special boxes are normally shipped in the order they should be installed and therefore should be stored in the order of delivery.

STORING

Storing of boxes should be done as near to the final installation destination as possible. If stacking of boxes is advisable, a flat surface with no rocks should be chosen for the first layer. Follow the manufacturer's recommendations for an acceptable stack height.

Gaskets and sealing materials should be stored in a cool dry place until needed. Rubber gaskets and bulk mastic or preformed mastics should be kept clean and away from excessive heat. Some mastics may need to be heated under extreme cold conditions, and tar joint compound should also be heated for optimum behavior during application.

SITE PREPARATION

EXCAVATION

Trenches should be excavated to the dimensions and grade specified on the plans or as ordered by the owner. The width of the trenches should be kept to the minimum required for installation of the box sections (ASCE 26-97). The trench width should take into account the machinery needed to properly install the box section. Over excavated areas should be backfilled with approved materials and compacted to the Standard Proctor density specified for the leveling course.

Preparation of the site should establish a good level grade, using fine to medium granular material. When ledge rock, compacted rocky, or other unyielding foundation material is encountered, it should be removed to the requirements shown on the plans. The foundation should be moderately firm to hard in-situ soil, stabilized soil or compacted fill material. If unstable or unsuitable material is encountered, it should be removed and replaced with stable material approved by the engineer.

Stockpiling excavated material adjacent to the trench could cause a surcharge load, which may cave-in the trench walls. The ability of the trench walls to stand vertically under this additional load depends on the cohesive characteristics of the particular type of material being excavated. This surcharge load should be considered when evaluating the need to provide trench support. It may be necessary where deep or wide trenches are being excavated to haul away a portion of the excavated soil or spread the stockpile with a bulldozer or other equipment. If the excavated material is to be used as backfill, the stockpiled material should be visu-

ally inspected for rocks, frozen lumps, highly plastic clay or other objectionable material. If the excavated soil differs significantly from the intended backfill material set forth in the plans, it may be necessary to haul the unsuitable soil away and bring in select backfill material.

TRENCHWATER

In the case where the water table is located in the trench zone, dewatering methods must be employed to remove the water. The future location of the water table must also be considered due to its effect on backfill material and the box section. The presence of water around the box could cause flotation of the box section, or migration of the backfill material. Migration of soil should be prevented, as the backfill is a means of support for the box.

There are different methods that can be used to remove this water: pumping, ditching, and/or piping of the water. It should be noted that all pumping should be through a filtered discharge.

BEDDING/GRADE

Precast reinforced concrete box sections are designed for installed conditions rather than test conditions. Designs are presented in ASTM Standards C 1433(M) and C 1577(M), and AASHTO M 259(M) and M 273(M). Bedding details for box sections are as illustrated. Proper support for a box culvert consists of specified bedding material having uniform flat surface characteristics (no low or high points), as these could create stress concentrations in the box after installation. The box, once installed, will not normally settle; it cannot be forced down to grade. Coarse bedding materials are not beneficial due to their irregular shape and sharp angles; instead medium to fine granular material should be used (less

than 1 1/2 in. preferred but no larger than 2 in.). If the construction site is located in a region where the ground is frozen, remove the frozen lumps and replace them with designer approved material.

A bedding thickness of no less than 3 in. (75 mm) should be used. The width of the bedding material should equal the width of the box (span plus twice the wall thickness) and the length of the bedding material should equal the length of the box. In the event that the leveling course consists of layers with the upper layer being clean, uncompacted sand, that layer shall be a maximum thickness of 2 in. (50 mm) to prevent non-uniform settlement from personnel and equipment during the installation process. If rock strata or boulders are encountered under the box section within the limits of the required leveling course, the rock or boulders shall be removed and replaced with additional leveling course material. Caution: A concrete slab is not considered an appropriate leveling course.

The box will tend to pull some bedding material toward the connection as it is aligned with the previous box. Excess bedding material trapped in the joint will prevent a proper alignment and connection and hence should be prevented. Therefore, at the connection end, a small trench (a shovel length wide and running the length of the bedding material) should be dug. This allows for the bedding material to fall into the trench instead of the joint when the box is pulled into place.

All bedding material characteristics should correspond to code and designer's plans for the specific project. Correct installation requires that the box culvert be installed on properly graded bedding. Any discrepancies in the installation of the culvert regarding bedding or grade should be addressed with the engineer for remedial action.

BEDDINGS PRECAST CONCRETE BOX SECTIONS (INCHES)

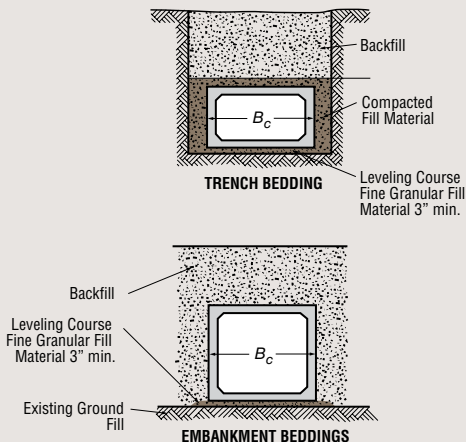

BEDDINGS PRECAST CONCRETE BOX SECTIONS (MILLIMETERS)

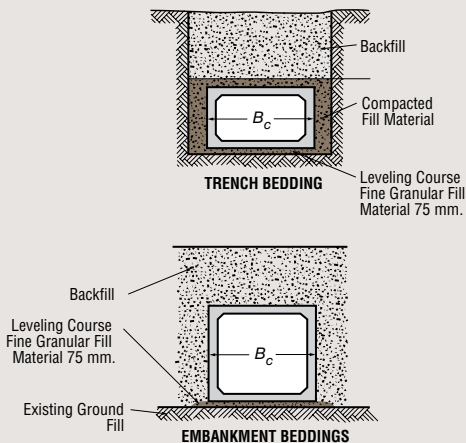

INSTALLATION

BOX ALIGNMENT

It is critical that the first box sections be installed correctly as they will determine the line and grade of the following boxes. If these are not correct, future connections may be affected.

BOX PLACEMENT

Placement of boxes should start at the outlet end of the line of box sections. The bell end should point upstream and the spigot or tongue should point downstream. Unless otherwise approved by the owner, loads from construction equipment transferred to a box section before, during, or after fill placement, either directly or through the fill, should not be greater than the loads assumed in the design (ASCE 26-97). Using excavating machinery for the purpose of pushing boxes into place should be avoided, since this could cause cracking, requiring on-site repairing. Also, dropping or dragging the section over gravel or rock is not advised.

A proper foundation for construction equipment should be available in order to ensure that no damage is caused to the leveling course and the side-walls of the excavation area.

JOINTING

Jointing is important in reducing the migration of soil fines and water between box sections and their surroundings. Depending on the use of the box culvert, various materials and methods may be used for sealing the joints.

Box culverts specified for a soil-tight joint can be sealed between the joint with a bituminous mastic sealant. Either liquid butyl (bulk mastic) or non-shrink grout can be added to the outside top slab

and applied down the sidewall 12 in. (300 mm) as well as applied to the inside bottom slab and inside sidewalls; or butyl sealant 1 in. (25 mm) thick and placed on the inside bottom and halfway up the sides of the bell end (approximately 1/2 in. (13 mm) from edge) and placed on the outside top and halfway down the sides of the spigot end (approximately 1/2 in. (13 mm) from edge) can be used to seal a soil tight joint. In cold weather it may be necessary to heat the butyl sealant with a hot water bath, bottle gas torch, or both. Placing this joint material in a sunny location, just prior to use, will allow heat absorption and make it more workable. Different grades of joint material are available for different temperatures.

Another joint commonly used is an extruded sealant which is placed between the joints. The extruded sealant can be applied in the same manner as the bituminous sealant, applied to the bell and spigot end of the sections being joined. In some areas, rubber gasket box joints may be available. Pre-made foam gaskets can also be used to seal joints. However these forms of sealant will have to be manually attached to the bottom of the spigot end of the box to prevent sagging.

If the seal is insufficient then an added layer of adhesive joint wrap (butyl rubber laminated to polyethylene vapor retarder) can be used on the outside of the box to prevent infiltration. The external sealing band can also be non-woven geotextile and should be placed on the sides and top of the box after installation. In certain situations all four sides can be wrapped. In this case the geotextile material can be slipped under the box before it is set then the sides and top can be sealed after the box is in place. It is desirable for the sealant to be one continuous strip, however if this is not practical, then

the top strip should be one piece and extend down the sides of the box a distance of 12 in. (300 mm) and overlap with the strip extending from the bottom.

CONNECTING THE BOXES

When joining boxes together, chains or winches should be used. Direct contact between installation machinery and the box sections is prohibited. Use appropriate cushion material between the box section and the machine to prevent spalling.

Before placing the box culvert in its final location, check to see that the grade is correct, the joint surface is cleared of all bedding material and the joint sealant is properly seated.

A workman should be in a position to guide the crane operator as the box is being aligned. The workman in the alignment position should direct the crane operator to lower the box until the top slab of the box section is approximately two feet above the top slab of the previously placed box. The box should be lowered in such a way that the sides of the boxes are flush and the spigot end of the installed box slips in line with the bell end of the receiving section. Even though the box is in the right position the weight of the section should be maintained by the crane.

Now the joint needs to be secured. This can be done through the use of winches or come-a-longs. Place one end of the come-a-long or winch at the far end of the installed sections and over the outer end of the next section taking care not to spall each surface. This works best if a pair of winches or come-alongs are used, one on each side. Gradually tighten the chains until the box section is snug against the previously placed box. This winching should be done uniformly. If the joint is not within the

maximum allowable joint opening, the crane should carefully lift the section slightly without breaking out the joint on top while the winches are pulling the chains taut. If this does not fix the open joint – remove the section and re-screed the bedding. Also check the sections to make sure that the dimensional tolerances will allow the joint to go home. When the box is in the right position the crane can gradually release the box so that the bedding material carries the entire weight of the box and then it can be disconnected. The chains are held securely until the crane is disconnected, and then they are released.

COMPLETION

After the boxes have been joined together the lift holes should be plugged according to the manufacturer's recommendation.

BACKFILL

Backfill should be placed in uniform layers along the sides of the boxes and over the top of the box sections. These layers should be no greater than the maximum allowed to achieve the required density. The characteristics of the backfill material should be determined from the contract specifications and should contain no debris, organic matter, frozen material or large stones with a diameter greater than 1/2 the thickness of the compacted layers being placed. When vibratory methods are needed to compact the backfill material, care should be taken so that no damage is done to the box section.

If sheathing and trench shields are used and are not part of the designer's soil structure plan, they should be incrementally removed, depending on the availability and readiness of backfill material. When trench shields are removed take care not

to disturb the installed boxes. Restraining the box may be necessary to hold it in place. If any voids are created in the side fill material they should be filled and compacted.

Once the envelope of backfill material is placed and properly compacted, the remainder of the fill or backfill should be placed and compacted to prevent settlement at the surface. Compaction and equipment loads should not exceed the box design strength. Several types of compaction equipment are available and certain types are best for particular types of soils. The steel wheeled roller is best suited for compacting coarse aggregate such as slag, coarse gravel and graded rock aggregates. The sheepfoot roller is best for cohesive clays or silts, but is not suitable for use on granular soils. Specially designed rubber tired rollers, which provide both static weight and kneading action, are applicable to many soils from clays to sand.

Regardless of the type of compaction equipment used, the backfill or fill material should be consistent with density requirements of the particular installation specified.

MINIMUM COVER FOR CONSTRUCTION LOADS

If construction equipment is going to travel over installed box sections, compacted backfill should be placed to a minimum of 3 ft. (1 m) over the top of the box section unless the box has been specifically designed for the anticipated construction loads. Above all, the loads applied to the box section should not exceed those specified by the designer. In an embankment installation, the minimum amount of backfill should extend one box section span or 3 ft. (1 m), whichever is larger, in each di-

rection to prevent lateral displacement. If construction traffic is large, the crossing point should be occasionally changed so that lateral displacement is minimized.

VISUAL INSPECTION

Large box sections can be entered and examined. TV cameras are another means of visually inspecting installed boxes. A checklist is provided below for an overall visual inspection of a sewer or culvert project.

- Debris
- Excessive cracks or large cracks
- Joints properly sealed
- Invert smooth and free of sags or high points
- Lift holes properly filled
- Hookups, diversions and connections properly made
- Catch basins and inlets properly connected
- Manhole frames and covers properly installed
- Surface restoration and all other items pertinent to the construction properly completed.

III. SPECIFICATIONS

Concrete pipe and box culverts are manufactured to nationally accepted standard specifications published by the American Society for Testing and Materials (ASTM), the American Association of State Highway and Transportation Officials (AASHTO), Federal specifying agencies, and others. The specifications are for manufacturing and purchase, and include material, design, tests, tolerance, inspection and acceptance criteria.

Specifications for concrete pipe have been developed by ASTM, which enable its use over a wide range of applications. These ASTM specification designations, and AASHTO and Canadian counterparts are:

AASHTO M 259 (M 259M): Precast Reinforced Concrete Box Sections for Culverts, Storm Drains, and Sewers: Covers reinforced concrete box sections in 42 standard sizes and shapes under 2 ft. (0.6 m) or more of earth cover for three loading conditions; dead load only, HS20 truck plus dead load, and alternate interstate loading plus dead load.

AASHTO M 273 (M 273M): Precast Reinforced Concrete Box Sections for Culverts, Storm Drains,

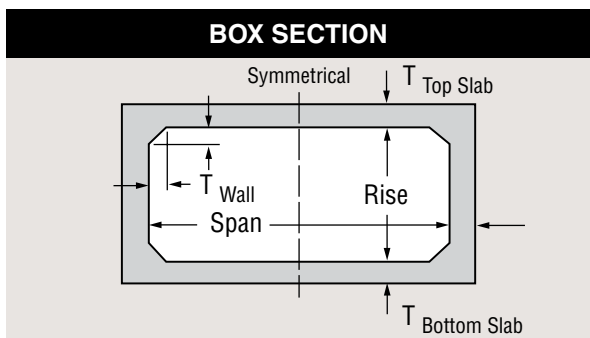

and Sewers with Less than 2 ft. (0.6 m) of Cover: Covers reinforced concrete box sections in 42 standard sizes and shapes under less than 2 ft. (0.6 m) of earth cover for two loading conditions; HS20 truck plus dead load, and alternate interstate loading plus dead load.

ASCE 26-97: Standard Practice for Direct Design of Buried Precast Concrete Box Sections: Covers the direct design and construction requirements of buried one-cell precast reinforced concrete box sections intended to serve as tunnels or for the conveyance of sewage, industrial wastes, storm water, and drainage.

CIRCULAR

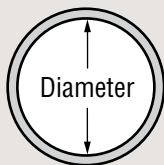

ASTM C 14 (C 14M), AASHTO M 86, CSA A 257.1: Concrete Sewer, Storm Drain and Culvert Pipe: Covers non-reinforced concrete pipe from 4 in. (100 mm) to 36 in. (900 mm) diameter in three strength classes.

ASTM C 76 (C 76 M), AASHTO M 170 (M 170M), CSA A 257.2: Reinforced Concrete Culvert, Storm Drain and Sewer Pipe: Covers reinforced concrete pipe in five strength classes. Class I – 60 to 144 in. (1500 mm to 3600 mm), Classes II, III, IV, V are for 12 in. to 144 in. (300 mm to 3600 mm). Larger sizes and higher classes are available as special designs.

ASTM C 118 (C 118M): Concrete Pipe for Irrigation or Drainage: Covers concrete pipe sizes from

6 to 24 in. (150 mm to 600 mm) in diameter intended to be used for the conveyance of irrigation water under low hydrostatic heads, generally not exceeding 25 ft. (75 kilopascals), and for use in drainage in sizes from 4 in. to 24 in. (100 mm to 600 mm) in diameter. For drainage applications two strength classes are covered: standard and heavy duty.

HORIZONTAL ELLIPTICAL

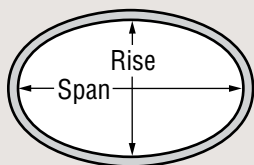

ASTM C 361 (C 361M): Reinforced Concrete Low-Head Pressure Pipe: Covers reinforced concrete pipe intended to be used for the construction of pressure conduits with low internal hydrostatic heads generally not exceeding 125 ft. (375 kilopascals) in sizes from 12 in. to 108 in. (300 mm to 2700 mm) in diameter.

ASTM C 412 (C 412M), AASHTO M 178 (M 178M): Concrete Drain Tile: Covers non-reinforced concrete drain tile with internal diameters from 4 in. to 36 in. (100 mm to 900 mm). Four strength classes are covered, standard quality, extra quality, special quality, and heavy-duty extra quality.

ASTM C 443 (C 443M), AASHTO M 198 (M 198M), CSA A 257.3: Joints for Circular Concrete Sewer and Culvert Pipe, with Rubber Gaskets: Covers joints where infiltration or exfiltration is a fac-

tor in the design, including the design of joints and the requirements for rubber gaskets to be used therewith for pipe conforming in all other respects to ASTM C 14 (C 14M) or ASTM C 76 (C 76M).

VERTICAL ELLIPTICAL

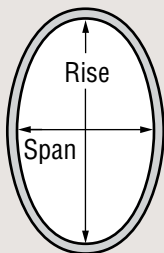

ASTM C 444 (C 444M), AASHTO M 175 (M 175M):

Perforated Concrete Pipe: Covers perforated concrete pipe intended to be used for underdrainage in sizes 4 in. to 27 in. (100 mm to 675 mm) and larger in diameter.

ASTM C 478 (C 478M), AASHTO M 199 (M 199M):

Precast Reinforced Concrete Manhole Sections: Covers precast reinforced concrete manhole riser sections and appurtenances such as grade rings, tops and special sections for use in sewer and water works.

ASTM C 497 (C 497M), AASHTO T 33, CSA A

257.0: Testing of Concrete Pipe or Tile: Covers procedures for testing concrete pipe or tile.

ASTM C 505 (C 505M): Non-reinforced Concrete

Irrigation Pipe with Rubber Gasket Joints: Covers pipe sizes from 6 in. to 24 in. (150 mm to 600 mm) in diameter to be used for the conveyance of irrigation water with working pressures, including hydraulic transients, of up to 30 ft. (9

m) of head. Higher pressures may be used up to a maximum of 50 ft. for 6 in. to 12 in. (15 m for 150 mm to 300 mm) in diameter, and 40 ft. for 15 in. to 18 in. (12 m for 375 mm to 450 mm) in diameter by increasing the strength of the pipe.

ASTM C 506 (C 506M), AASHTO M 206 (M 206M): Reinforced Concrete Arch Culvert, Storm Drain and Sewer Pipe: Covers arch pipe in three strength classes in sizes from 15 in. to 132 in. (375 mm to 3300 mm) in equivalent circular diameter based on cross-sectional area. Larger sizes are available as special designs.

ARCH PIPE

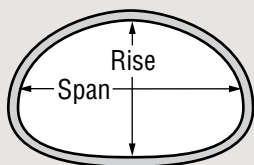

ASTM C 507 (C 507M), AASHTO M 207 (M 207M): Reinforced Concrete Elliptical Culvert, Storm Drain and Sewer Pipe: Covers reinforced elliptically shaped concrete pipe. Five standard classes of horizontal elliptical, 18 in. to 144 in. (450 mm to 3600 mm) in diameter and five standard classes of vertical elliptical, 36 in. to 144 in. (900 mm to 3600 mm) in diameter are included. Equivalent circular sizes are based on cross-sectional area. Larger sizes are available as special designs.

ASTM C 655 (C 655M), AASHTO M 242 (M 242M): Reinforced D-Load Culvert, Storm Drain and Sewer Pipe: Covers acceptance of pipe design and production pipe based upon the D-load

concept and statistical sampling techniques for concrete pipe to be used for the conveyance of sewage, industrial waste and storm water and construction of culverts.

ASTM C 822 (C 822M), AASHTO M 262 (M 262M): Definition of Terms Relating to Concrete Pipe and Related Products: Includes definitions for words and terms occurring in concrete pipe standards.

ASTM C 877 (C 877M): External Sealing Bands for Noncircular Concrete Sewer, Storm Drain and Culvert Pipe: Covers external sealing bands for noncircular concrete pipe conforming to ASTM C 506 (C 506M), C 507 (C 507M), C 1433 (C 1433M), C 1504 (C 1504M), C 1577 (C 1577M).

ASTM C 923 (C 923M): Resilient Connectors Between Reinforced Concrete Manhole Structures and Pipes: Covers the minimum performance and material requirements for resilient connections between pipe and reinforced concrete manholes conforming to ASTM C 478M (C 478).

ASTM C 924 (C 924M): Testing Concrete Pipe Sewer Lines by Low-Pressure Air Test Method: Covers procedures for testing concrete pipe sewer lines by low-pressure air test to demonstrate the integrity of the installed material and the construction procedures.

ASTM C 969 (C 969M): Practice for Infiltration and Exfiltration Acceptance Testing of Installed Precast Concrete Pipe Sewer Lines: Covers procedures for testing installed precast concrete pipe sewer lines using either water infiltration or exfiltration acceptance limits to demonstrate the integrity of the installed materials and construction procedures.

- ASTM C 985 (C 985M): Non-reinforced Concrete Specified Strength Culvert Storm Drain, and Sewer Pipe:** Covers non-reinforced concrete pipe designed for specified strengths and intended to be used for the conveyance of sewage, industrial wastes, and storm water and for the construction of culverts.
- ASTM C 990 (C 990M): Specification for Joints for Concrete Pipe, Manholes, and Precast Box Sections Using Preformed Flexible Joint Sealants:** Covers joints for precast concrete pipe and box, and other sections using preformed flexible joint sealants for use in storm sewers and culverts which are not intended to operate under internal pressure, or are not subject to infiltration or exfiltration limits.
- ASTM C 1103 (C 1103M): Practice for Joint Acceptance Testing of Installed Precast Concrete Pipe Sewer Lines:** Covers procedures for testing the joints of installed precast concrete pipe sewer lines, when using either air or water under low pressure to demonstrate the integrity of the joint and the construction procedures.
- ASTM C 1214 (C 1214M): Test Method for Concrete Pipe Sewer Lines by Negative Air Pressure (Vacuum) Test Method:** Covers using the negative air pressure test for 4 in. to 36 in. (100 mm to 900 mm) in diameter circular concrete pipe sewer lines utilizing gasketed joints.
- ASTM C 1244 (C 1244M): Standard Test Method for Concrete Sewer Manholes by the Negative Air Pressure (Vacuum) Test Method:** Covers using the negative air pressure test for concrete sewer manholes utilizing gasketed joints.
- ASTM C 1433 (C 1433M): Precast Reinforced Concrete Box Sections for Culverts, Storm Drains,**

and Sewers: Covers single-cell reinforced concrete box sections intended to be used for the construction of culverts and for the conveyance of storm water industrial wastes and sewage.

ASTM C 1479: Standard Practice for Installation of Precast Concrete Sewer, Storm Drain, and Culvert Pipe Using Standard Installations: covers the installation of precast concrete pipe intended to be used for the conveyance of sewage, industrial wastes, and storm water and for the construction of culverts.

ASTM C 1577 (C 1577M): Precast Reinforced Concrete Box Sections for Culverts, Storm Drains, and Sewers Designed According to AASHTO LRFD: Covers single-cell precast reinforced concrete box sections intended to be used for the construction of culverts, and for the conveyance of storm water, industrial wastes and sewage.

ASTM C 1619: Standard Specification for Elastomeric Seals for Joining Concrete Structures: Covers the physical property requirements of elastomeric seals (gaskets) used to seal the joint of precast concrete structures conforming to specifications C 14 (C 14M), C 118 (C 118M), C 361 (C 361M), C 443 (C 443M) or C 505 (C 505M) used in gravity and low head pressure applications.

ASTM C 1628: Standard Specifications for Joints for Concrete Gravity Flow Sewer Pipe, Using Rubber Gaskets: Covers flexible leak resistance joints for concrete gravity flow sewer pipe using rubber gaskets for sealing the joints, where measurable or defined infiltration or exfiltration is a factor of the design.

IV. APPENDIX

DEFINITIONS

Backfill or Side Fill: the layer of soil placed around or above the pipe or box unit.

Bedding: the material used to cushion and evenly distribute the soil reaction at the bottom of the structure.

Bell End: that portion of the end of the pipe or box unit, regardless of its shape or dimensions, which overlaps a portion of the end of the adjoining pipe or box culvert.

Box Culvert/Section: A culvert with a rectangular cross section

Concrete: a thoroughly mixed blend of Portland cement, fine aggregate, coarse aggregate, and water. The mixture may also contain admixtures, or other cementitious materials, or both.

Culvert: a pipeline or box intended to convey water under a highway, railroad, canal, or similar facility.

External Sealing Bands: flexible wrappings that are applied to the outside of a concrete pipe, box section, or manhole section joint intended to control the movement of fluids or solids through the joint.

Gradation: the distribution of particles of granular material among standard sizes usually expressed in terms of cumulative percentages larger or smaller than each of a series of sieve openings.

Handling Reinforcement: reinforcement intended to reduce the risk of collapse of the pipe or section during handling or storage prior to and during final placement.

Infiltration: the volume of groundwater entering a sewer and its connections through pipe, boxes, joints, connections or appurtenances.

Installed Length: final length, along the centerline, of a pipe or box section in place including the longitudinal joint separation between the section and the last section placed.

Invert: the bottom or lowest point of the internal surface of the transverse cross section of a pipe.

Joint: a connection of two pipe, manhole, or box section ends, made either with or without the use of additional parts and/or materials.

Lift Hole: a small hole cast or drilled in the wall of the pipe or section for inserting a bolt, loop of cable or other device used in handling the pipe or section.

Lot: an assemblage of concrete pipe or box culverts, all being of like size, material, and strength designation, manufactured by the same process. The lot size may differ from the quantity designated in the contract or order.

Manhole: a Precast concrete structure for vertical access to a pipeline or other closed structure.

O-Ring Gasket: a solid gasket of circular cross section that is recessed in a groove on the pipe tongue or spigot and then confined by the bell or groove after the joint is completed.

Permeability: that property which permits movement of a liquid through the pores and interstices of the concrete

Pipe: a tube or elongated hollow concrete structure intended to transmit flow between locations.

Pipe Diameter: the inside diameter of a concrete pipe

Pipe Section: a single pipe.

Pipeline: pipe sections joined together.

Preformed Flexible Joint Sealant: pliable material formed into a defined cross section that is applied to the surface of a pipe, box section, or manhole section joint, intended to control the movement of fluids or solids through the joint.

Reinforced Concrete Pipe: a pipe structure comprised of concrete and steel reinforcement. Such reinforcement is comprised of steel wire, welded wire reinforcement, or bars, of known strength, formed into a cage and positioned in the concrete wall in a specific location in such a manner that the two materials act together to resist stresses.

Reinforcement: steel in the form of wire, welded wire fabric, or bars embedded in concrete in such a manner that the above referenced concrete and steel act together to resist stresses.

Resilient Connector: a flexible connection for joining pipe to structures capable of being deformed and deflected without rupture or leakage.

Rubber Gasket: rubber formed and used as a seal in concrete pipe joints.

Spigot: that portion of the end of the pipe, regardless of its shape or dimensions, which is overlapped by a portion of the end of the adjoining pipe.

Springline: the points on the internal surface of the transverse cross section of a pipe intersected by the line of maximum horizontal dimension; or in box sections, the mid-height of the internal vertical wall.

Watertight: will restrain the passage of water to not exceed a specified limit.

**FEET HEAD OF WATER
INTO PRESSURE, POUNDS
PER SQUARE INCH**

Feet Head	Lbs. per Square Inch
1	.43
2	.87
3	1.30
4	1.73
5	2.17
6	2.60
7	3.03
8	3.40
9	3.90
10	4.33
15	6.50
20	8.66
25	10.83
30	12.99
35	15.16
40	17.32
45	19.40
50	21.65
55	23.82
60	25.99
65	28.15
70	30.32
75	32.48
80	34.65
85	36.81
90	38.98
95	41.14
100	43.31
110	47.64
120	51.97
130	56.30
140	60.63
150	64.96
160	69.29
170	73.63
180	77.96
190	82.29
200	86.62
225	97.45
250	108.27
275	119.10
300	129.93
325	140.75
350	151.58

**FEET HEAD OF WATER
INTO KILOPASCALS
(kN/m²)**

Feet Head	kPa
1	2.99
2	5.98
3	8.96
4	11.95
5	14.94
6	17.93
7	20.92
8	23.91
9	26.90
10	29.89
15	44.83
20	59.77
25	74.71
30	89.66
35	104.60
40	119.54
45	134.48
50	149.43
55	164.37
60	179.31
65	194.25
70	209.20
75	224.14
80	239.08
85	254.02
90	268.97
95	283.91
100	298.85
110	328.73
120	358.62
130	388.51
140	418.39
150	448.28
160	478.16
170	508.05
180	537.93
190	567.81
200	597.70
225	672.41
250	747.13
275	821.84
300	896.55
325	971.26
350	1046.00



American **Concrete Pipe** Association

info@concretepipe.org

© 2007 - 2020 American Concrete Pipe Association,
all rights reserved.
Resource No 01-103